

SHARP

MX-6070N/MX-5070N
MX-4070N/MX-3570N/MX-3070N
MX-4060N/MX-3560N/MX-3060N
Digital Full Colour Multifunctional System

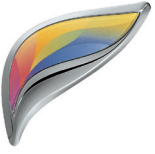

Model shown MX-6070N

A3 COLOUR MFPs WITH
ADVANCED FEATURES FOR
CONNECTED TEAMS

Knowledge drives success /**This is Why** our MFPs optimise
the way you create, manage and share information.

You want to work smarter /This is Why you should empower your team with our next-generation technology.

These next generation MFPs break new ground in office efficiency and ease of use. With advanced ergonomic design and forward-thinking connectivity, they're designed to perform right at the heart of your information infrastructure, reducing costs and optimising workflows.

Empowering your team

Whichever model you choose - 60, 50, 40, 35 or 30 pages per minute - our smart technology will help everyone in your team work the way they want to.

An advanced Single Sign-On capability improves productivity by connecting people to their favourite cloud storage services such as Google Drive™, SharePoint® and OneDrive®, direct from the control panel. Printing directly from the cloud and scanning documents from the MFP up to the cloud takes just moments. Sign on once, access everything! And mail service connectors conveniently send scanned data directly to recipients in your Gmail™ or Microsoft Exchange account.

Smarter technology

These MFPs are packed full of the features you need for maximum productivity. As you approach it, a motion sensor will detect you and the MFP will awake from sleep mode, ready to process any jobs with no waiting at all.

A large, colour touch screen that tilts for easy viewing gives you intuitive access to every function, with an embedded 'quick help' guide to illustrate each step.

The screen lets you drag and drop menu icons for faster access to your frequently used functions and supports multi-touch pinch and spread gestures. A preview function enables easy viewing and editing of documents prior to printing.

And as no one likes interruptions, you'll be reassured to know that you can even top up the toner* and paper supplies without pausing the print/copy run.

MOTION SENSOR WAKES THE MFP WHEN SOMEONE APPROACHES, SO IT IS ALWAYS READY

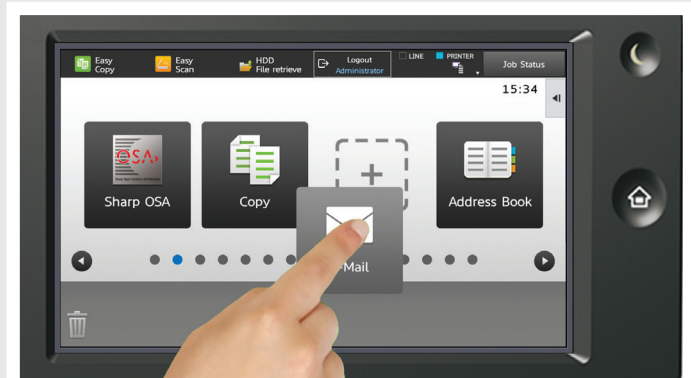

HOME PAGE WITH EASY DRAG & DROP STYLE CUSTOMISATION



* MX-6070N/MX-5070N only.

Time is often limited /This is Why our MFPs are designed to do so much more.

All MFPs can print, copy and scan. But our range of next generation MFPs will do so much more. They can act as a print server to give you 'Pull Printing' capability. That means you can use the convenient Print Release feature to print your documents at any Sharp MFP, in the same range, that's on your network*1.

Not only does this ensure confidentiality because your documents are never left unattended, but it adds convenience by eliminating the need to carry piles of paper around with you.

First class scanning

Scanning is very fast at 200*2/80*3 impressions per minute and the Auto Colour Mode lets you process mixed batches of colour and black & white documents automatically, even if they are of different sizes and weights. Just stack them in the 150-sheet Duplex Single Pass Feeder (DSPF)*2 or the 100-sheet Reversing Single Pass Feeder (RSPF)*3 and let the MFP do the rest.

A powerful Optical Character Recognition feature enables you to scan your document in a range of formats including fully searchable PDF files as well as editable Microsoft Office format such as Word, PowerPoint or Excel. The need to re-type documents that you only have in hard copy is completely eliminated whilst ease of accessing and finding information is vastly improved.

If you have Microsoft Office files on a USB memory stick you can simply plug into the MFP, select your files and start printing. Scanning to the memory stick, or to the cloud or for immediate output, is just as easy.

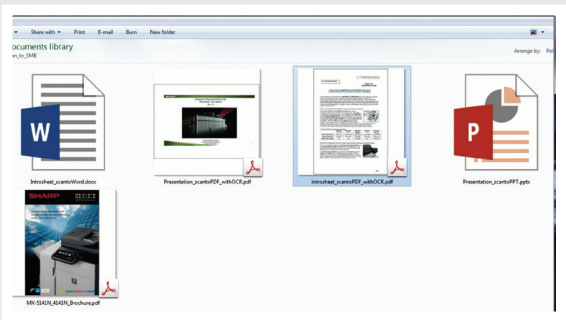

CONVERT SCANNED DOCUMENTS INTO EDITABLE OFFICE FILES AND SEARCHABLE PDFS WITH OCR

SIMPLY PLUG YOUR USB MEMORY STICK INTO THE MFP AND START PRINTING

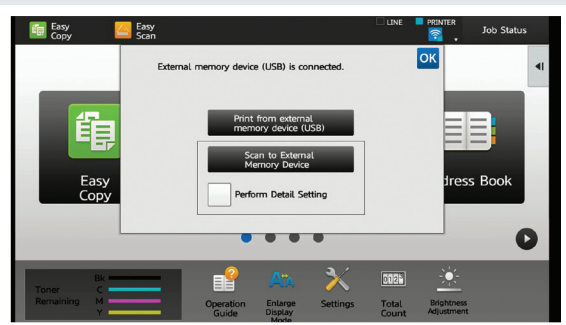

FAST SCANNING VIA THE DSPF OR RSPF

*1 The Print Release function can be used from any of five network-connected printers.

*2 MX-6070N/MX-5070N/MX-4070N/MX-3570N/MX-3070N only.

*3 MX-4060N/MX-3560N/MX-3060N only.

You focus on results not technology /This is Why our MFPs support the way you like to work.

Flexibility in document handling means greater versatility in your output. Paper trays accommodate up to SRA3 media with weights up to 300 g/m². And you can choose from a wide range of finishing options including saddle-stitching, manual and stapleless stapling.

Excellence comes as standard

All eight models produce rich, vibrant colour with 1200 x 1200 dpi resolution, and our Auto Process Control and 'developer refresh' system guarantee page after page of consistently excellent output.

Made for a mobile world

Work anywhere at any time. Sharpdesk Mobile lets everyone in your team print from and scan to their phones and tablets over your wireless network, and you can print from any App which supports Google Cloud Print* or the Android printing framework (Sharp Print Service Plugin). Industry leading security features keep your data and network safe and secure.

Energy efficient

Low melt toner, configurable and automatic power on/off settings, Eco Scan and a short warm up time are just some of the many features that ensure extremely low energy consumption.

In addition, the front panel display will prompt users to select the most environmentally friendly option before starting a job and the toner cartridge automatically ejects only when the toner has been fully exhausted, eliminating waste.

Tough security

When you make your MFP and all the documents in your cloud available to everyone, you'll want to know that they are safe and secure. So you'll be pleased to know that our latest MFPs come with all the security features of our earlier models, plus S/MIME for secure email communications, advanced data protection and high security logins and user authentication.

MANUAL STAPLING
FOR UP TO 40
SHEETS (80 g/m²)



STAPLELESS STAPLING
IS AVAILABLE FOR UP
TO 4 SHEETS OF PAPER

* Not available in every country.

Effective teams need efficient technology /This is Why our next-generation MFPs are optimised for productivity.

The smart technology of these next generation MFPs will transform the productivity of any workgroup. Your whole team will find that printing, copying, scanning and finishing documents is fast, easy and efficient. But that's just the start.

If you couple one of these MFPs with Cloud Portal Office and one or more of our Optimised Software Solutions, you'll see productivity elevated to an even higher level.

Cloud Portal Office

Our award-winning cloud-based document management system lets you capture, store, manage, share and retrieve all of your business documents safely and securely, from any web enabled device including phones, tablets, PCs, Sharp MFPs and our BIG PAD interactive display solutions.

When enabled on one of these new MFPs, everyone gets on-demand, walk-up access to every document they've stored in the cloud. Just log on at the control panel, browse and print. You can also scan automatically indexed documents directly to a folder in the cloud, and send email alerts to colleagues who need them, all from the MFP.

Optimised Software Solutions

We created our range of Optimised Software Solutions to help you reduce costs, increase efficiency and improve security.

Our **Optimised Printing Solutions** help you monitor and manage your print and copy usage, so you can eliminate unauthorised use, track and recover costs and reduce waste.

Our **Optimised Scanning Solutions** save time and prevent costly errors by simplifying and automating the capture, storage and sharing of documents, regardless of their format or purpose.

Our **Optimised Mobile Solutions** help people to connect tablets, phones and laptops simply and securely, so they're always in touch.

Our **Optimised Workflow Solutions** help reduce costs and streamline repetitive tasks, restoring the business productivity you need to achieve and maintain profitable growth.

All this, plus the power of these new MFPs will enable you to optimise your workforce productivity and enhance your profitability.

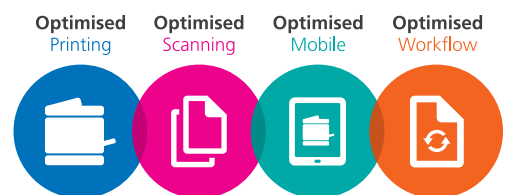

CLOUD READY MFP



Configuration Examples

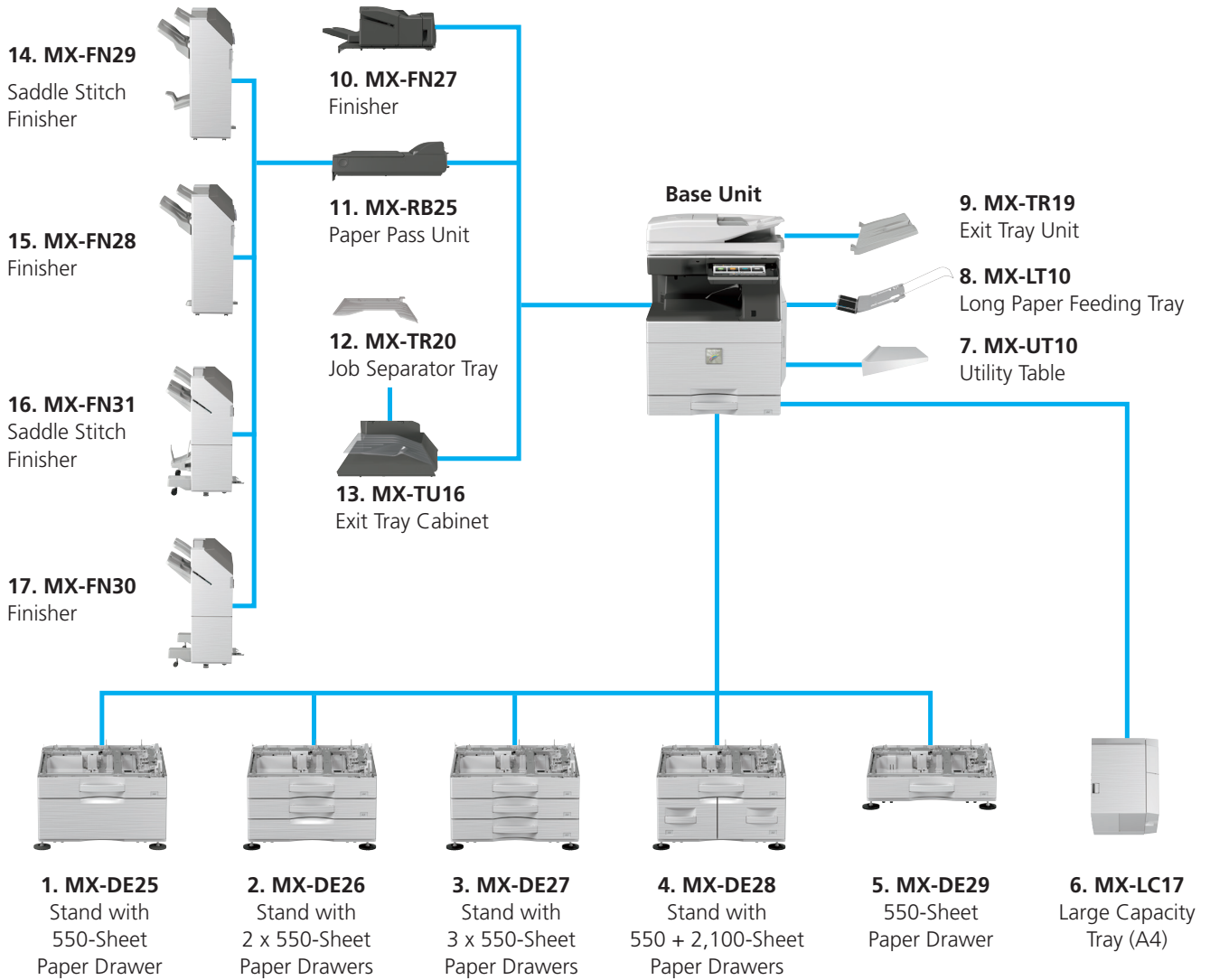

MX-3560N Base Unit
Job Separator Tray
Stand with 3 x 550-Sheet Paper Drawers
Exit Tray Unit



MX-4070N Base Unit
Inner Finisher
Stand with 550 + 2,100-Sheet Paper Drawers
Exit Tray Unit



MX-6070N Base Unit
Saddle Stitch Finisher + Paper Pass Unit
Stand with 550 + 2,100-Sheet Paper Drawers
Exit Tray Unit
Large Capacity Tray

Base Unit

1. MX-DE25 Stand with 550-Sheet Paper Drawer

550 sheets*¹, SRA3 to A5R (60 - 300 g/m²)

2. MX-DE26 Stand with 2 x 550-Sheet Paper Drawer

550 sheets*¹ each for lower and upper trays, SRA3 to A5R (60 - 300 g/m²)

3. MX-DE27 Stand with 3 x 550-Sheet Paper Drawer

550 sheets*¹ each for lower and upper trays, SRA3 to A5R (60 - 300 g/m²)

4. MX-DE28 Stand with 550 + 2,100-Sheet Paper Drawer

Upper tray: SRA3 – A5R, 550 sheets*¹ (80 g/m²)

Lower tray (Left): A4, 1,200 sheets*¹ (60 - 105 g/m²)

Lower tray (Right): A4 - B5, 900 sheets*¹ (60 - 105 g/m²)

5. MX-DE29 550-Sheet Paper Drawer

550 sheets*¹, SRA3 to A5R (60 - 300 g/m²)

6. MX-LC17 Large Capacity Tray (A4)

3,000 sheets*¹, A4 - B5 (60 - 220 g/m²)

7. MX-UT10 Utility Table

Finishing

8. MX-LT10 Long Paper Feeding Tray

Recommended for banner printing

9. MX-TR19 Exit Tray Unit

10. MX-FN27 Inner Finisher

A3 - B5 (offset/staple), SRA3 - A5R (non offset)

Offset tray (upper): max. 500-sheet paper capacity*¹

Stapling capacity: max. 50-sheet multi-position staple*¹

Staple position: 3 locations (front, rear or 2 point stitching)

Manual Stapling: 1-point at rear (Flat), 45 sheets (64 g/m²),

40 sheets (80 g/m²)

Stapleless capacity: max.5-sheet (64 g/m²), 4 sheet (65 – 81.4 g/m²),

3 sheet (81.5 - 105 g/m²)

Stapleless position: 1-point at rear (Slant), A3 - B5

Optional Punch Module for MX-FN27:

MX-PN14C - 2/4 Hole Punch Module

MX-PN14D - 4 Hole Wide Punch Module

11. MX-RB25 Paper Pass Unit

Required when using MX-FN28, MX-FN29, MX-FN30 & MX-FN31

12. MX-TR20 Job Separator Tray

Requires MX-TU16 Exit Tray Cabinet

13. MX-TU16 Exit Tray Cabinet

14. MX-FN29 1k Saddle Stitch Finisher

A3W - A5R (offset/staple), SRA3 - A5R (non offset)

Offset tray (upper): max.1,000-sheet paper capacity*¹

Stapling capacity: max. 50-sheet multi-position staple*¹

Staple position: 1-point at front (Flat), 1-point at back (Flat),

2 point stitching

Saddle stitch tray (lower): 7 sets (11-15 sheets), 10 sets (6-10 sheets),

20 sets (1-5 sheets). 15 sheets max per set

15. MX-FN28 1k Finisher

A3W - A5R (offset/staple), SRA3 - A5R (non offset)

Offset tray (upper): max.1,000-sheet paper capacity*¹

Stapling capacity: max. 50-sheet multi-position staple*¹

Staple position: 1-point at front (Flat), 1-point at back (Flat),

2 point stitching

Optional Punch Module for MX-FN29 & MX-FN28:

MX-PN15C - 2/4 Hole Punch Module

MX-PN15D - 4 Hole Wide Punch Module

16. MX-FN31 3k Saddle Stitch Finisher

A3 - B5 (offset/staple), SRA3 - A5R (non offset)

Offset tray (upper): max.3,000-sheet paper capacity*¹

Stapling capacity: max. 65-sheet multi-position staple*¹

Staple position: 1-point at front (Slant), 1-point at back (Slant),

2 point stitching

Manual Stapling: 1-point at rear (Flat), 45 sheets (64 g/m²),

40 sheets (80 g/m²)

Stapleless capacity: max.5-sheet (64 g/m²), 4 sheet (65 – 81.4 g/m²),

3 sheet (81.5 - 105 g/m²)

Stapleless position: 1-point at rear (Slant), A3 - B5

Saddle stitch tray (lower): 10 sets (11-15 sheets),

15 sets (6-10 sheets), 25 sets (1-5 sheets). 20 sheets max per set

17. MX-FN30 3k Finisher

A3 - B5 (offset/staple), SRA3 - A5R (non offset)

Offset tray (upper): max.3,000-sheet paper capacity*¹

Stapling capacity: max. 65-sheet multi-position staple*¹

Staple position: 1-point at front (Slant), 1-point at back

(Slant), 2 point stitching

Manual Stapling: 1-point at rear (Flat), 45 sheets (64 g/m²),

40 sheets (80 g/m²)

Stapleless capacity: max.5-sheet (64 g/m²), 4 sheet (65 – 81.4 g/m²),

3 sheet (81.5 - 105 g/m²)

Stapleless position: 1-point at rear (Slant), A3 - B5

Optional Punch Module for MX-FN31 & MX-FN30:

MX-PN16C - 2/4 Hole Punch Module

MX-PN16D - 4 Hole Wide Punch Module

Printing

MX-PF10 Barcode Font Kit

Enables barcode printing

Faxing

MX-FX15 Fax Expansion Kit

MX-FWX1 Internet Fax Expansion Kit

Scanning

AR-SU1 Stamp Unit

Marks already scanned documents for checking

Sharpdesk Licenses

MX-USX1/X5

1/5-License Kit

MX-US10/50/A0

10/50/100-License Kit

Sharp OSA®

MX-AMX1 Application Integration Module

Security

MX-FR52U*² Data Security Kit

Commercial Version

*¹ Number of sheets based on 80 g/m². *² Available at a later date.

Specifications

General

Engine speed (ppm/cpm) (Max)	A4*	A3	SRA3
MX-6070N	60	30	29
MX-5070N	50	26	24
MX-4070N/MX-4060N	40	20	18
MX-3570N/MX-3560N	35	18	16
MX-3070N/MX-3060N	30	16	15
Control panel display 10.1-inch colour LCD touchscreen			
Paper size (Min – Max)	SRA3 – A5*2		
Paper weight (g/m ²)			
Tray	60 – 300		
Multi-bypass	55 – 300		
Paper capacity (Std – Max)			
Sheets	650 – 6,300		
Drawers	1 – 4 (plus bypass tray)		
Warm-up time *3 (seconds)			
MX-6070N/MX-5070N	15		
MX-4070N/MX-3570N/MX-3070N	10		
MX-4060N/MX-3560N/MX-3060N	10		

Memory (GB)	
Copier/Printer (shared)	5
HDD*4	500
Power requirements	Rated local AC voltage ±10%, 50/60 Hz
Power consumption (kW) (Max)	
MX-6070N/MX-5070N	2.07 (220 to 240V)
MX-4070N/MX-3570N/MX-3070N	1.84 (220 to 240V)
MX-4060N/MX-3560N/MX-3060N	1.84 (220 to 240V)
Dimensions (mm) (W x D x H)	
MX-6070N/MX-5070N	616 x 660 x 838
MX-4070N/MX-3570N/MX-3070N	616 x 660 x 838
MX-4060N/MX-3560N/MX-3060N	608 x 650 x 834
Weight (kg)	
MX-6070N/MX-5070N	90
MX-4070N/MX-3570N/MX-3070N	87
MX-4060N/MX-3560N/MX-3060N	79

Copier

Original paper size (Max)	A3	
First copy time *5 (seconds)	Full colour	B/W
MX-6070N/MX-5070N	4.8	3.7
MX-4070N/MX-3570N/MX-3070N	6.7	4.7
MX-4060N/MX-3560N/MX-3060N	6.7	4.7
Continuous copies (Max)	9,999	
Resolution (dpi)		
Scan (colour)	600 x 600	
Scan (B/W)	600 x 600, 600 x 400	
Print	1,200 x 1,200, 600 x 600, 9,600 (equivalent) x 600 (depending on copy mode)	
Gradation levels	256	
Zoom range (%)	25 – 400, (25 – 200 using DSPF/RSPF) in 1% increments	
Preset copy ratios (Metric)	10 ratios (5R/5E)	

Network Scanner

Scan method	Push scan (via control panel) Pull scan (TWAIN-compliant application)	
Scan speed *6 (ipm) (Max)	One-sided	Two-sided
MX-6070N/MX-5070N	100	200
MX-4070N/MX-3570N/MX-3070N	100	200
MX-4060N/MX-3560N/MX-3060N	80	25
Resolution (dpi) (Max)		
Push scan	100, 150, 200, 300, 400, 600	
Pull scan	75, 100, 150, 200, 300, 400, 600 50 to 9,600 dpi via user setting	
File formats	TIFF, PDF, PDF/A, encrypted PDF, compact PDF*7, JPEG*7, XPS, searchable PDF, Microsoft® Office (pptx, xlsx, docx), text (TXT), rich text (RTF)	
Scan destinations	Scan to e-mail, desktop, FTP server, network folder (SMB), USB memory, HDD	
Scanner utility	Sharpdesk	

Wireless LAN

Compliant regulation	IEEE802.11n/g/b
Access mode	Infrastructure mode, Software AP mode
Security	WEP, WPA/WPA2-mixed PSK, WPA/WPA2-mixed EAP*8, WPA2, PSA, WPA2 EAP*8

External Dimensions

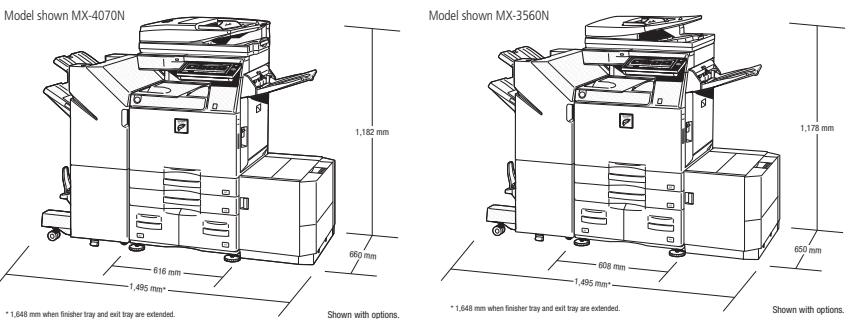

Notes

*1 Long-edge feeding. *2 Only short-edge feeding can be used with A5 paper. *3 At rated voltage, 23°C (73.4°F). May vary depending on operating conditions and environment. *4 HDD capacity depends on procurement and sourcing status. *5 Long-edge feeding of A4 sheets from 1st paper tray, using document glass, without Auto Colour Selection and Auto Colour mode, MFP in fully ready condition. May vary depending on operating conditions and environment. *6 Based on Sharp's A4 standard chart, using document feeder and long-edge feeding. Using factory default settings with Auto Colour Selection off. Scan speed will vary depending on the type of document and the scan settings. *7 Colour only. *8 Not applicable to Software AP mode. *9 Storage capacity will vary depending on the type of document and the scan settings. *10 Some features require option(s). *11 Based on Sharp's standard chart with approx. 700 characters (A4 long-edge feeding) at standard resolution in Super G3 mode, 33,600 bps, JBIG compression

Design and specifications are subject to change without prior notice. All information was correct at time of print. The ENERGY STAR logo is a certification mark and may only be used to certify specific products that have been determined to meet the ENERGY STAR programme requirements. ENERGY STAR is a US registered mark. Windows, Windows NT, Windows XP and Windows Vista are registered trademarks of Microsoft Corporation. Adobe and PostScript 3 are either registered trademarks or trademarks of Adobe Systems Incorporated in the U.S. and/or other countries. All other company names, product names and logos are trademarks or registered trademarks of their respective owners. ©Sharp Corporation August 2016. Ref: MX-6070N/MX-5070N/MX-4070N/MX-3570N/MX-3070N/MX-4060N/MX-3560N/MX-3060N Brochure Job: (17618). All trademarks acknowledged. E&OE.

Sept 2016 Edition

SHARP



Pantone authentication for MX-4070N/MX-3570N/MX-3070N and MX-4060N/MX-3560N/MX-3060N only.

Inspiring ideas from technology

www.sharp.co.uk

SHARP BUSINESS SYSTEMS UK PLC
4 FURZEGROUND WAY
STOCKLEY PARK
UXBRIDGE
MIDDLESEX UB11 1EZ
TEL: +44 (0)20 8734 2000

DEALER STAMP