

SHARP

Be Original.

MX-C301W

Digital Full Colour Multifunctional System



**Small but Mighty—A4 Colour MFP
Boasts A3 MFP Performance
and Handy Wireless Connectivity**



Don't Let Size Fool You— This Compact A4 Solution Is Big on Function

Despite its stylishly streamlined appearance, the MX-C301W is an A4 powerhouse of functionality. Built for quality performance and four-in-one efficiency, the MX-C301W is packed with the same advanced features usually reserved for larger A3 MFPs. That's what makes it the ideal workflow enhancer for businesses of any type and size. In fact, this versatile solution works equally well in large offices as part of a network of A3/A4 MFPs and in smaller offices as the solo document performer.

EXPANDABILITY

Built-In Wireless Connections

The MX-C301W offers ultra-handry wireless access via two easy modes: infrastructure mode and access point mode. These two modes enable the MFP to accommodate various user-environment factors, such as installation location and the type of LAN available.

Infrastructure mode

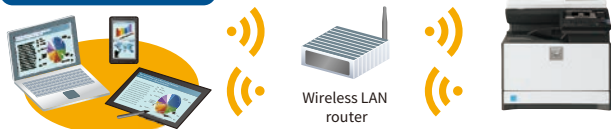

Infrastructure mode wirelessly connects the MFP to notebook PCs and other mobile devices via a commercially available wireless LAN router. This ensures convenient access to the MFP even from places where wired LAN is not available.

Access point mode



Access point mode wirelessly connects a LAN-wired MFP to notebook PCs and other mobile devices without going through a wireless LAN router. The MFP can be accessed via both a wired connection and a wireless connection.

Note: External networks cannot be accessed via the MFP. Up to five mobile devices can be wirelessly connected to the MFP at the same time.

Sharpdesk Mobile*

Sharpdesk Mobile is a mobile print/scan application that combines the convenience of mobile devices and the efficiency of Sharp MFPs to make conducting business on the go easier than ever. Documents scanned on a Sharp MFP can be sent to a mobile device to preview and save. Documents saved on a mobile device can be printed out on the MFP, sent as e-mail attachments, or used in other applications.

* Availability varies by country/region. For details, see the Sharpdesk Mobile support website:
http://sharp-world.com/products/copier/docu_solutions/mobile/sharpdesk_mobile/

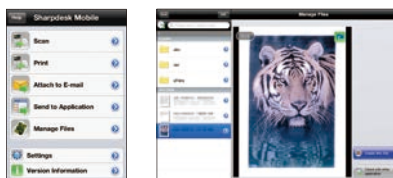

Sharp OSA* (Open Systems Architecture)

Innovative Sharp OSA technology allows you to interact with critical business and network applications right from the LCD control panel, offering a new realm of control and convenience. The latest version provides support for both Internet- and intranet-based applications. And since Sharp OSA utilizes industry-standard network protocols, the MX-C301W can easily integrate with document management systems, enterprise resource planning software, workflow applications, and more. Sharp OSA brings other benefits as well, such as reducing the costs associated with system implementation and management and enabling data sharing across company branch offices or subsidiaries.

* Requires optional MX-AMX2 and/or MX-AMX3.

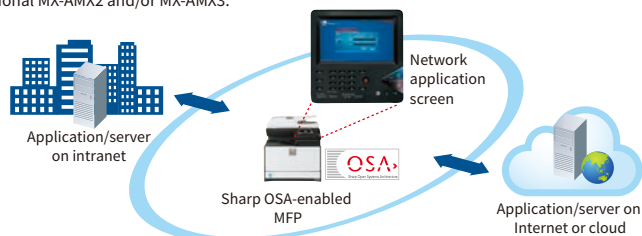

Efficient Colour and B/W Output

The MX-C301W delivers a fast output of 30 ppm* in full colour and in B/W. And the first copy comes out in just 6.3 seconds in B/W and 7.4 seconds in full colour to save valuable time when performing multiple short-run jobs. A warm-up time of just 18 seconds brings added efficiency.

* A4 (8 1/2" x 11"), short-edge feeding

Superb Image Quality

Third-generation Mycrostoner-HG3 (High Grade) expands the colour reproducibility range for a more natural rendering of clear blue skies, emerald green oceans, and other colour images. And the smaller particle size of the toner and the carrier allows for reduced graininess and clear reproduction of fine lines, fine text, and halftone colours.

Easy, High-Quality Copying

The MX-C301W comes standard with **Auto Colour Mode** to deliver high-quality automated copying. This function allows the MFP to make clear, easy-to-read copies from documents that contain not only text but also photos and maps. Here's how it works: Auto Colour Selection automatically determines whether a page is colour or B/W. The contents of each page are then analysed to distinguish between different components, such as photos and text, and the appropriate copy mode for that page is selected. Finally, Background Suppression automatically removes unnecessary background colour for clearer output.

Auto Colour Mode

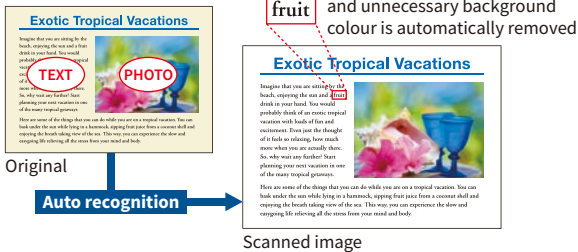

RSPF and Built-In Duplex Module

The MX-C301W comes standard-equipped with a 50-sheet RSPF (reversing single pass feeder) for efficient document feeding and a built-in stackless duplex module for two-sided copying and printing that effectively reduces paper costs and saves filing space. A Business Card Copy function on the RSPF lets the MX-C301W copy business cards in two layouts: one card per page and eight cards per page.



Business Card Copy

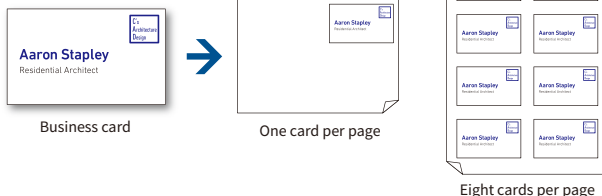

Proof Copying or Printing

To prevent the waste of large-volume misprints, the MX-C301W lets users output only the first set to check the content, adjust settings if necessary, and then initiate output of the rest of the job from the LCD control panel.

Direct Printing

The MX-C301W can print PDF, TIFF, JPEG, or XPS* files without using the printer driver. And there's a USB port to the side of the control panel, which comes in handy when printing data directly from USB memory devices—an indispensable function for users who are in a hurry or who want quick machine access without a PC.



* Direct XPS printing requires optional MX-PUX1 and 2GB of extra memory.

ID Card Copy

The MX-C301W has a dedicated on-screen button for easy copying of both sides of a card (ID cards, credit cards, etc.) onto a single page.



Other Key Features

- Total paper capacity of **800 sheets**
- Accommodates heavy paper up to **220 g/m²**
- **Watermark** prints a user-selected watermark, such as "Urgent," on each page to indicate the status of the document
- **Multi-Shot** copying and **N-up** printing
- **Pamphlet Style** copying/printing
- Works with the latest and most commonly used operating systems and network protocols, including **IPv6**
- Supports, as standard, **PCL 6** and **PostScript® 3™**
- **Form Overlay** can store office document formatting such as letterheads and overlay contents in colour, eliminating the need for pre-printed paper
- **Barcode font** compatibility*

* Requires optional MX-PF10.

- Image editing functions: **Photo Repeat**, **Mirror Image**, **XY Zoom**, **B/W Reverse**, and more
- **Card Shot** enables easy copying—in the user-selected size—of both sides of a card onto a single page
- **Colour Stamp** labels your copies with page numbers, the date, or text such as "Urgent" in up to four different colours
- **Mixed Size Original Copy** mode automatically recognises when mixed-size documents of the same width are fed through the RSPF and chooses the appropriate paper

Full-Colour Network Scanning

The MX-C301W works as a full-colour network scanner and supports TIFF, PDF, PDF/A, encrypted PDF, JPEG, and XPS file formats. Converting any type of paper-based document into an editable digital file is as easy as making a copy. And Auto Colour Selection chooses the right mode for scanning originals containing both colour and B/W pages (see page 2).

Quick Scanning

For both colour*¹ and B/W documents, the MX-C301W carries out scanning at max. 35 opm*² (one-sided) and can complete large scan jobs with ease and efficiency.

*1: Faxing is available in B/W only.

*2: Originals per minute; when feeding A4 (8 1/2" x 11") sheets.

Skip Blank Page Function

When scanning and sending a multi-page document, the MX-C301W automatically recognises and skips over any pages without content, reducing both data size and transmission time.

Multiple Distribution of Scanned Files

You can choose different ways to distribute your scanned documents: for example, send as an e-mail attachment or scan directly to an FTP server for storage.

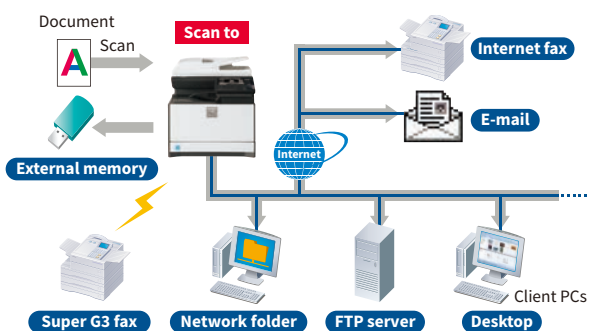

Business Card Scanning

The MX-C301W can easily scan business cards* with its RSPF and can be used with commercially available business card scan software to create business card databases.

* One-sided scanning



LDAP Support

Built-in LDAP (lightweight directory access protocol) support eliminates the need to enter or register full addresses. Entering just the first few letters of a recipient's name prompts the MX-C301W to display a list of possible matches from your company's LDAP server. Selected addresses can be stored to the MX-C301W's address book.

High-Speed Faxing

The MX-C301W also works as a 33.6 Kbps Super G3 fax machine. Quick On-Line Transmission initiates dialling and transmitting as soon as a page is scanned into memory. JBIG compression technology lets the MX-C301W send an A4 (8 1/2" x 11") size page in under three seconds*. And using the 50-sheet RSPF gives faxing efficiency a further boost. Incoming faxes are also handled with automated ease. The number of copies to be made can be specified on the LCD control panel's Fax Output setting.

* Based on Sharp's standard chart with approximately 700 characters (A4 or 8 1/2" x 11") at standard resolution.

PC-Fax/PC-Internet Fax

Directly send a document created on your PC to a recipient's fax machine via a phone line or the Internet without printing to paper. Save time and paper costs while retaining original document quality.

Note: PC-Internet Fax requires optional MX-FWX1.

Internet Fax

Economically send and receive faxes to and from other ITU-T T-37-compliant Internet fax machines via the Internet. The MX-C301W supports Direct SMTP; outgoing Internet faxes do not go through your mail server, making transmission faster and cheaper.

Note: Requires optional MX-FWX1.

Paperless Faxing with Inbound Routing

Paperless faxing with inbound routing lets you check incoming faxes via e-mail before printing. It can also forward incoming faxes to another fax/Internet fax machine, an FTP server, a network folder (SMB), or a PC desktop. Files can be saved in either PDF or TIFF (single/multi).

Other Key Features

- **One-touch auto dial keys** register up to **1,000** numbers for frequently used destinations
- **Broadcast transmission** to up to 500 destinations
- **Program keys** (up to 48 keys) are available to set up frequently used transmissions for instant recall
- **Easy text entry*** lets you enter addresses, file names, subject titles, or messages from the LCD control panel

* Only addresses can be entered for faxing.

- **Mixed size original scanning** automatically recognises when mixed-size documents of the same width are fed through the RSPF

-
- **Duplex transmission/reception** sends and prints out two-sided documents
 - **SD memory card backup** ensures documents remain safely backed up in memory, even in the event of a power failure
 - **Rotation transmission/reception** rotates incoming and outgoing faxes to match the direction of the printing paper
 - **Fax destination confirmation** allows users to reconfirm fax numbers before sending to prevent transmission errors

Document Management on the Hard Disk

You can save processed job data in designated folders on the MX-C301W's built-in hard disk, making it easy to instantly recall saved documents or jobs for printing and sending at a later time. This contributes greatly to efficient sharing and distribution of information in your business operations.

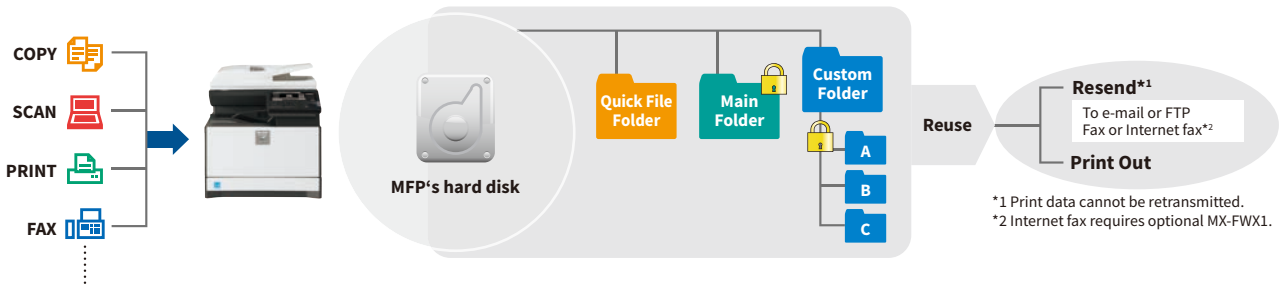

Quick Filing

Up to 10,000 pages or 1,000 files*³ that have been copied, printed, scanned, or faxed*⁴ can be stored by job in a Quick File Folder. You can easily reuse saved data without having to reload or rescan the original.

Advanced Filing Function

Up to 20,000 pages or 3,000 files*³ that have been copied, printed, scanned, or faxed*⁴ can be stored by job on the hard disk in up to 1,000 folders with customised names and locations. Enhanced security features require users to enter a 5- to 8-digit password to access secure folders, protecting your sensitive data. Storage options include Main Folder for workgroup sharing and Custom Folder for enhanced-security archiving.

*3: Storage capacity will vary depending on the type of document and the scan settings.

*4: For fax and Internet fax jobs, only transmitted data (not received faxes) can be saved in the Document Filing function.

Easy Access to Stored Files

Documents stored on the hard disk can be quickly and easily searched and accessed from the control panel's LCD via thumbnail displays and file previews or through a Web browser.



Thumbnail displays

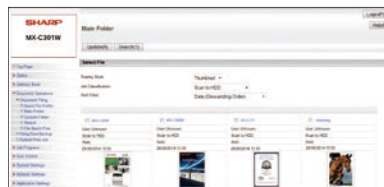

Web access screen

Easy Sharing of Application Files

To facilitate file sharing across the office network, the MX-C301W provides 50GB of hard disk storage space for folders. Each folder can hold up to 500 files created with applications such as Word and Excel® and saved in their original format.

Note: Sharp recommends backing up data saved to the MFP's hard disk.

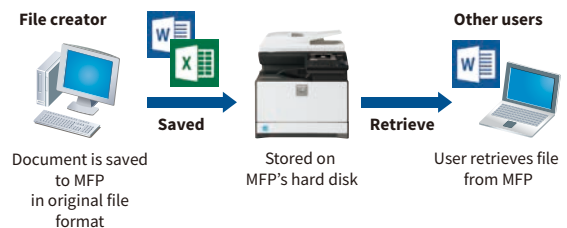

Sharpdesk for Total Document Management

Sharpdesk is an original Sharp application that provides integrated desktop management of documents in over 200 file formats, including scanned paper-based documents and those created with popular applications such as Word. It allows you to organise, edit, search, and distribute your documents, all with simple drag-and-drop operation.

- Intuitive desktop display features thumbnail viewing
- Sharpdesk Imaging provides annotation tools for paper-free proofreading
- Sharpdesk Composer combines different types of files into a single document
- Optical character recognition converts documents into editable text files
- Output zone distributes files to e-mail, printers, and other applications

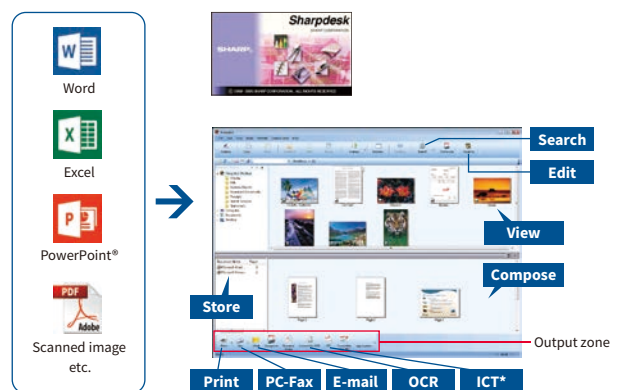

Industry-Leading Multi-Layered Security

Designed to protect your business assets and bring you peace of mind, Sharp's security solutions employ multiple levels of security functions—both standard equipped and optional—covering a broad range of network and data security needs. The MX-C301W safeguards sensitive data with powerful, enhanced security functions that eliminate the worry of unauthorised use and guarantee greater protection for your confidential information.

Secure Network Access

The IP/MAC address filtering function provides highly secure operation by restricting access to the MFPs on your office network. Only PCs that have either their IP address or MAC (media access control) address registered are allowed to use the MFPs. Attempted access from an unknown IP or MAC address will be denied, preventing unauthorised use. The MX-C301W also supports the IEEE 802.1X standard for port-based network access control, which blocks all access from unauthorised devices.

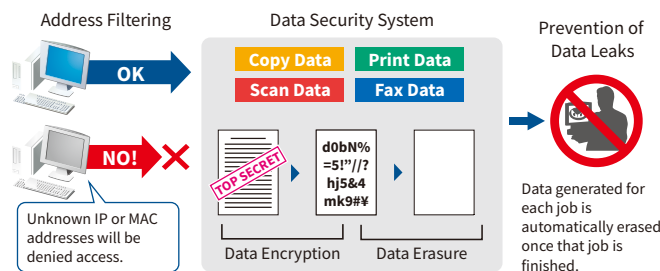

Data Encryption and Overwriting

Digital copier/printers and MFPs retain large amounts of data generated from copy/print/scan/fax jobs in internal storage. To safeguard confidential data from unauthorised access, standard-equipped security features on the MX-C301W automatically encrypt job data prior to saving it to internal storage. Once a job is finished, that encrypted data is erased via up to seven automatic overwrites. Protection of administrator/file/folder passwords brings further peace of mind.

Note: Contact a Sharp customer representative for details on activating these security functions.

User Authentication

The MX-C301W prevents unauthorised use by requiring passwords for machine access. This safeguarded solution can register up to 1,000 users in three access levels as Administrator, User, or Guest and can designate to which function user authentication applies. And the MX-C301W works with an external Active Directory® server to extend user authentication to multiple MFPs and a greater number of users.

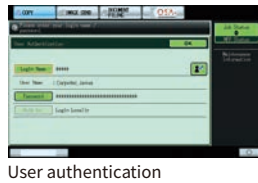

IPsec Support

The MX-C301W supports IPsec, a set of protocols for securing Internet protocol (IP) communications. IPsec encrypts and authenticates traffic between specified parties, giving IPsec-compatible products an extremely high level of network security.

Data Initialisation

The MX-C301W's initialisation function allows confidential information to be erased at the administrator's discretion via the MFP's system setting. Initialising an MFP when it's time to replace it prevents important resources, such as customer information and intellectual property, from leaking out and provides considerable peace of mind.

Encrypted PDF with Password Protection

To prevent unauthorised viewing of confidential data, the MX-C301W enables scanned PDF data to be password protected and encrypted for transmission over the network. After transmission, viewers can gain access to the encrypted PDF only after re-entering the password.

Secure Sockets Layer

SSL (secure sockets layer) enables the encryption of data communications to prevent data leakage through the network when printing via IPP, browsing secure Web pages (HTTPS), or communicating via e-mail (SMTP and POP3) or FTP (FTPS).

Scan to Me Function

Scan to Me lets a logged-in authorised user send scanned data to his/her own e-mail address simply by pressing the start button. This eliminates the need to manually enter or select the address, thereby preventing documents from being sent to the wrong address.

Document Control Function (option)

Document Control prevents unauthorised copying, scanning, faxing, and filing of confidential documents by embedding copy prevention data onto a document. When that data is detected, any unauthorised attempts to copy will be cancelled or will result in only blank-page output.

Note: Requires optional Data Security Kit. May not work for certain types of documents or paper.

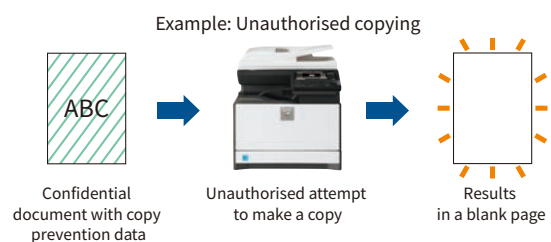

USER FRIENDLINESS

7.0-Inch Colour Touchscreen LCD

The MX-C301W is equipped with a 7.0-inch WVGA touchscreen colour LCD that provides easy navigation of MFP functions and settings. The LCD also shows thumbnail displays and data file previews, raising the bar on user friendliness.

Tiltable Control Panel

The control panel can be tilted for easy viewing, even from a wheelchair. The tilt angle can be set anywhere from 13.5 degrees to 63.5 degrees.



Job Status Screen

The LCD displays a list of all printing and copying jobs, conveniently indicating job order and progress. And the Priority Printing function allows users to easily change the job order or delete jobs that are no longer needed—right from the LCD screen.

Thumbnail Display and Previews

Displaying thumbnails and up-close previews of Document Filing data files along with file names on the MX-C301W's LCD makes searching for files easy and convenient. It can also prevent errors by allowing users to confirm scan settings and other such items before copying, scanning, or saving documents to the MFP's hard disk. Thumbnails and previews of incoming faxes and Internet faxes can also be displayed on the LCD to help users decide which documents to print out or forward to others.



Thumbnails



Preview

DEVICE MANAGEMENT

Web-Based System Settings

Administrators can manage every important setting—including user access and security as well as other controls and configurations—through a standard Web browser right from their desktops.

Network Utility Software

Sharp Remote Device Manager* (SRDM) gives administrators centralised control of their networked MFPs through a standard Web browser, making device cloning and other operations easier and more accessible.

* Contact a Sharp customer representative for availability and other details.

Remote Diagnosis

The MX-C301W can be monitored remotely through a Web browser, letting administrators handle tasks before they become problems. And when action or maintenance is required, the E-Mail Status and Alert function notifies administrators via timely e-mail alerts.

Device Cloning

Machine settings can be copied conveniently to another MX-C301W via a Web browser in XML format, making it easy to clone machines in a networked environment. With Device Cloning, the administrator no longer needs to set up individual machines one by one, thereby making his/her job a lot easier.

Remote Operation

The Remote Operation function lets you display the MFP's main control panel on your PC screen, allowing you to operate every major function directly from your desktop.* This function also enables the administrator to guide an MFP user through necessary procedures and allows remote MFP operation from a wheelchair.

* Requires VNC application.

ENVIRONMENT-FRIENDLY

Outstanding Energy Efficiency

The MX-C301W is certified for the ENERGY STAR® programme, an international system identifying energy-efficient products.



• Power ON/OFF Schedule function automatically turns the MX-C301W on or off according to time schedules set by the administrator.

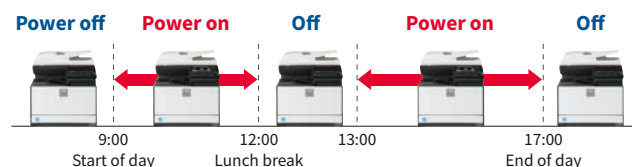

- Based on prior usage patterns, the MX-C301W automatically determines the optimal length of time to let elapse before going into auto power shut-off mode, helping reduce overall power consumption. And pressing the power save key after a job is finished immediately puts the MFP into auto power shut-off mode for further cutbacks on running costs.
- The time interval after which the MFP will go into auto power shut-off mode can be temporarily extended via the control panel.
- Eco Scan function saves energy by turning off power to the fusing system during jobs that don't require any printing, such as Image Sending and Document Filing.
- For further energy savings, energy-efficient LED lamps are employed in the scan unit in place of conventional xenon lamps. An ASIC (application-specific integrated circuit) also helps the MX-C301W deliver excellent performance and energy efficiency.

SPECIFICATIONS (tentative)

General

Type	Desktop
Engine speed	A4 (8 1/2" x 11")*1: Max. 30 ppm
Control panel display	7.0-inch colour LCD touchscreen
Paper size	Max. A4 (8 1/2" x 14"), min. A6 (5 1/2" x 8 1/2")
Paper capacity (80 g/m²)	Standard: 300 sheets (250-sheet tray and 50-sheet multi-bypass tray) Maximum: 800 sheets (300 sheets & optional 500-sheet tray)
Paper weight	Tray: 60 g/m ² to 105 g/m ² (16 lbs bond to 28 lbs bond) Multi-bypass tray: 55 g/m ² to 220 g/m ² (13 lbs bond to 80 lbs cover)
Warm-up time*2	18 sec.
Memory	Standard: 3GB (copy/print shared) 250GB HDD*3 Option: 2GB
Power requirements	Rated local AC voltage ±10%, 50/60 Hz
Power consumption	Max. 1.3 kW (220V to 240V), max. 1.25 kW (100V to 127V)
Dimensions (W x D x H)	429 x 569 x 474 mm (16 5/8" x 22 13/32" x 18 21/32")
Weight (approx.)	33 kg (72.8 lbs)

Copier

Original paper size	Max. A4 (8 1/2" x 14")
First copy time*4	Full colour: 7.4 sec. B/W: 6.3 sec.
Continuous copy	Max. 999 copies
Resolution	Scan*5: 600 x 600 dpi, 600 x 300 dpi Print: 600 x 600 dpi, 9,600 (equivalent) x 600 dpi
Gradation	Equivalent to 256 levels
Zoom range	25% to 400% (25% to 200% using RSPF) in 1% increments
Preset copy ratios	Metric: 8 ratios (4R/4E), inch: 5 ratios (3R/2E)

Document Filing

Document filing capacity*6	Main and custom folders: 20,000 pages or 3,000 files Quick file folder: 10,000 pages or 1,000 files
Stored jobs	Copy, print, scan, fax transmission
Storage folders	Quick file folder, main folder, custom folder (max. 1,000 folders)
Confidential storage	Password protection

*1: Short-edge feeding. *2: At rated voltage, 23°C (73.4°F). May vary depending on operating conditions and environment. *3: HDD capacity depends on procurement and sourcing status. *4: Short-edge feeding of A4 (8 1/2" x 11") sheets from paper tray, using document glass, without Auto Colour Selection and Auto Colour mode, MFP in fully ready condition. May vary depending on operating conditions and environment. *5: Default resolution is 600 x 600 dpi in colour when using document glass or RSPF, 600 x 600 dpi in B/W when using document glass, and 600 x 300 dpi in B/W when using RSPF. *6: Storage capacity will vary depending on the type of document and the scan settings. *7: IPv6 is supported only by LPR printing protocol. *8: XPS requires optional MX-PUX1 and 2GB memory. *9: Based on Sharp's A4 standard chart, using document feeder, short-edge feeding, and one-sided scanning. Using factory default settings with Auto Colour Selection off. Scan speed will vary depending on the type of document and the scan settings. *10: Resolution will vary depending on the size of the scanned area. *11: Colour/greyscale only. *12: Based on Sharp's standard chart with approx. 700 characters (A4 or 8 1/2" x 11") at standard resolution in Super G3 mode, 33,600 bps, JBIG compression.

Network Printer

Resolution	600 x 600 dpi, 9,600 (equivalent) x 600 dpi
Interface	USB 2.0, 10Base-T/100Base-TX/1000Base-T
Supported OS	Windows Server® 2008, Windows Server® 2008 R2, Windows Server® 2012, Windows Server® 2012 R2, Windows Server® 2016, Windows Vista®, Windows® 7, Windows® 8.1, Windows® 10, Mac OS X 10.6, 10.7, 10.8, 10.9, 10.10, 10.11, macOS Sierra
Network protocols	TCP/IP (IPv4, IPv6), IPX/SPX, EtherTalk (AppleTalk)
Printing protocols*7	LPR, Raw TCP (port 9100), POP3 (e-mail printing), HTTP, IPP, FTP for downloading print files, EtherTalk printing
PDL	Standard: PCL 6 emulation, PostScript® 3™ emulation Option: XPS*8
Available fonts	80 fonts for PCL, 136 fonts for PostScript 3 emulation

Network Scanner

Scan method	Push scan (via control panel) Pull scan (TWAIN-compliant application)
Scan speed*9	[Colour & B/W] Max. 35 originals/min.
Resolution	Push scan: 100, 200, 300, 400, 600 dpi Pull scan: 75, 100, 150, 200, 300, 400, 600 dpi 50 dpi to 9,600 dpi via user setting*10
File formats	TIFF, PDF, PDF/A, encrypted PDF, JPEG*11, XPS
Scanner utility	Sharpdesk
Scan destinations	Scan to e-mail/desktop/FTP server/network folder (SMB)/USB drive

Facsimile

Compression method	MH/MR/MMR/JBIG
Communication protocol	Super G3/G3
Transmission time	Less than 3 seconds*12
Modem speed	33,600 bps to 2,400 bps with automatic fallback
Transmission resolution	From Standard (203.2 x 97.8 dpi) to Ultra Fine (406.4 x 391 dpi)
Recording size	A4 to A5 (8 1/2" x 11" to 5 1/2" x 8 1/2")
Memory	1GB
Greyscale levels	Equivalent to 256 levels

• Design and specifications are subject to change without prior notice.
• PCL is a registered trademark of Hewlett-Packard Company. PostScript 3 is either a registered trademark or trademark of Adobe Systems Incorporated in the US and/or other countries. Active Directory, Windows, Windows Server, Windows Vista, Excel, and PowerPoint are registered trademarks of Microsoft Corporation in the US and/or other countries. Mac, OS X, macOS, EtherTalk, and AppleTalk are trademarks of Apple Inc., registered in the US and other countries. All other brand names and product names may be trademarks or registered trademarks of their respective owners.
• The ENERGY STAR logo is a certification mark and may only be used to certify products that have been determined to meet the ENERGY STAR programme requirements. ENERGY STAR and the ENERGY STAR mark are registered trademarks owned by the US Environmental Protection Agency. The ENERGY STAR guidelines apply to products only in the US, the EU, Japan, Canada, Australia, New Zealand, and Taiwan.

SYSTEM CONFIGURATION

 <p>RSPF</p> <p>MX-CS11 500-Sheet Paper Feed Unit</p>	<p>MX-PUX1 XPS Expansion Kit</p> <p>MX-PF10 Barcode Font Kit</p> <p>MX-FWX1 Internet Fax Expansion Kit</p> <p>MX-USX1/X5 Sharpdesk 1/5-License Kit</p> <p>MX-US10/50/A0 Sharpdesk 10/50/100-License Kit</p>	<p>MX-AMX1 Application Integration Module</p> <p>MX-AMX2 Application Communication Module</p> <p>MX-AMX3 External Account Module</p> <p>MX-FR46U Data Security Kit</p>
	<p>Certain options may not be available in some areas.</p>	

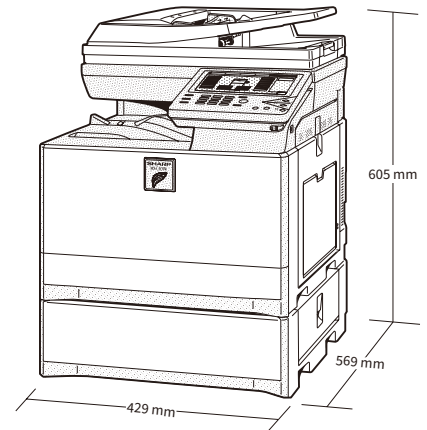

MX-C301W shown with option.

Distributed by: