

SHARP

ELECTRONIC CASH REGISTER

MODEL

XE-A207W/XE-A207B
XE-A217W/XE-A217B

Basic User Manual

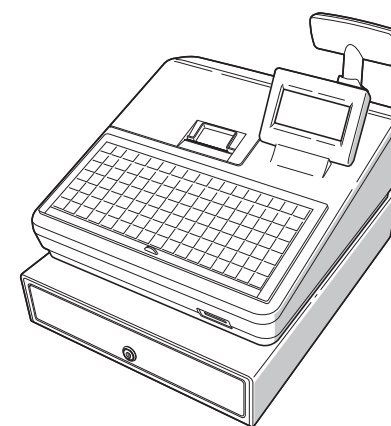
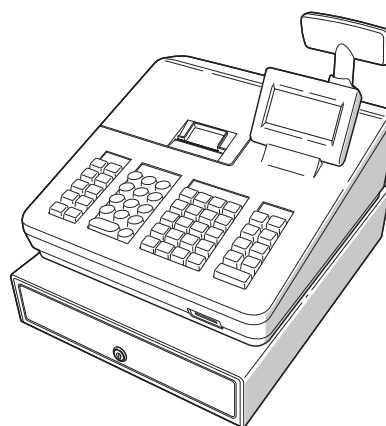

Printed in Korea
T(TINSE2607BHZZ) ①

Thank you very much for your purchase of the SHARP Electronic Cash Register, Model XE-A207W/XE-A207B, XE-A217W/XE-A217B.

Please read this manual carefully before operating your machine in order to gain full understanding of functions and features.

Please keep this manual for future reference. It will help you if you encounter any operational problems.

For a free download of the FULL DETAILED INSTRUCTION MANUAL, please go to the following related URL:

- The United Kingdom and Republic of Ireland: www.sharp-pos.co.uk
- Netherlands and Belgium and Luxemburg: www.sharp.nl
- Sweden: www.sharp.se

**For Easy Set-up,
See "Getting Started"**

Part Names and Functions

Front view (XE-A207W/XE-A207B)

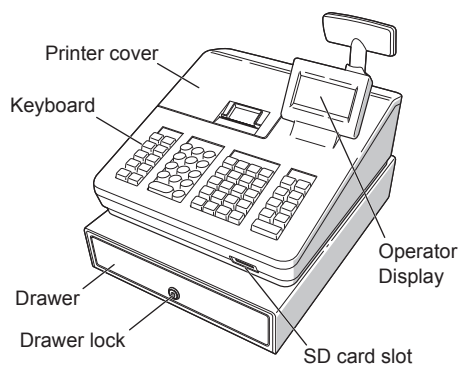

Front view (XE-A217W/XE-A217B)

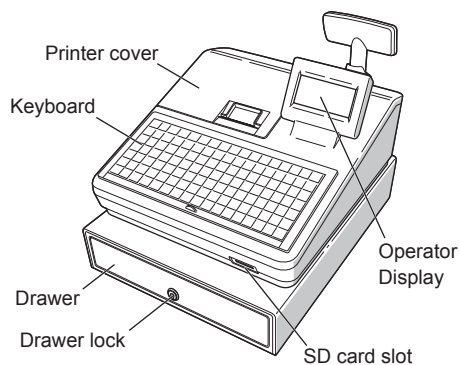

Rear view (XE-A207W/XE-A207B)
(XE-A217W/XE-A217B)

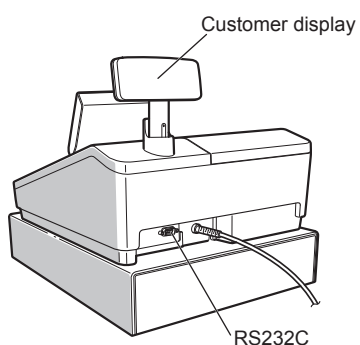

Selecting an Operating Mode

Press the **MODE** key. The following mode screen is displayed.

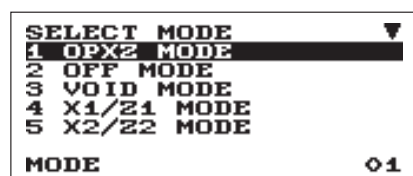

Use one of the following ways:

- Move the cursor to the desired option by using the **←** or **→** key, and press the **TL/NS** key.
- Enter the desired option number by using a numeric key, and press the **TL/NS** key.

You can select the following function.

OP XZ mode:
This mode allows clerks to take X or Z reports on their sales information.

OFF mode:
This mode locks all operations of the register. When you select this mode, the window will disappear. Pressing any key turns the register ON.

VOID mode:
This mode allows correction after finalizing a transaction.

X1/Z1 mode:
This mode is used to take various daily total reports (X1/Z1 reports).

X2/Z2 mode:
This mode is used to take various weekly or monthly reports (X2/Z2 reports).

PGM mode:
This mode is used to program various items.

SD CARD mode:
This mode allows you to save and load the data of your register to and from the SD card.

NOTE When you want to enter the REG mode, simply press the **ESC/CANCEL** key.

Customer display (Pop-up type)



Keyboard Layout

For XE-A207W/XE-A207B

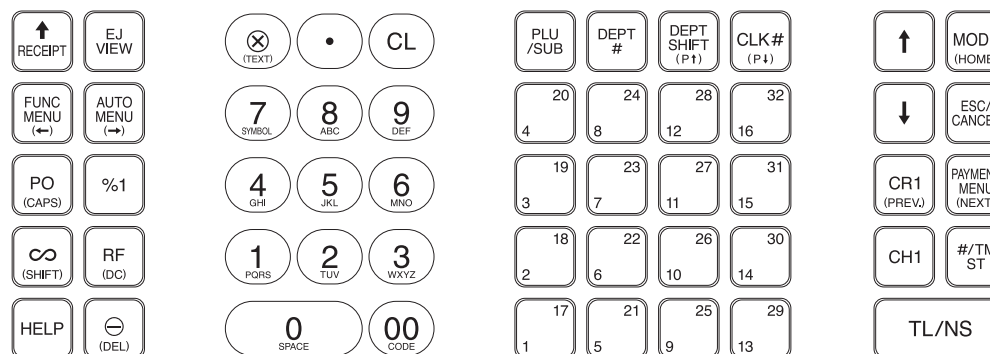

The following are used as control keys for text programming:

- DC**: This key toggles the double-size character mode and the normal-size character mode.
- SHIFT**: You can enter an upper-case letter by using this key.
- ←** **→**: Moves the cursor.
- DEL**: Deletes a character or figure in the cursor position.

For XE-A217W/XE-A217B

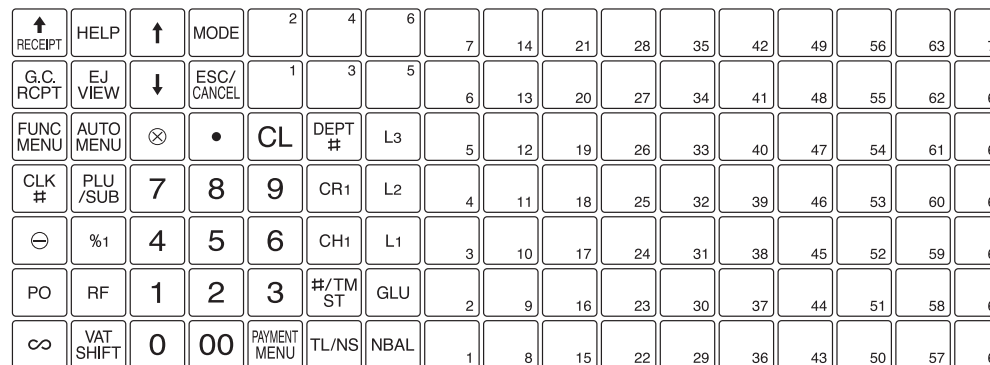

The following are used as control keys for text programming:

- DC**: This key toggles the double-size character mode and the normal-size character mode.
- SHIFT**: You can enter an upper-case letter by using this key.
- ←** **→**: Moves the cursor.
- DEL**: Deletes a character or figure in the cursor position.

Getting Started

Initializing the Cash Register

For your cash register to operate properly, you must initialize it before programming for the first time. Follow this procedure.

1. Remove the register from its packing carton.
2. Insert the plug into the AC outlet.

IMPORTANT: This operation must be performed without batteries loaded.

Never install the batteries into the cash register before initializing it. Before you start operating the cash register, you must first initialize it, then install two new alkaline batteries LR6 ("AA" size) on the register. Otherwise, distorted memory contents and malfunction of the cash register will occur.

Language Selection

1. Display the "Language Selection" after turning on the power.
2. Press the numeric key for the number of your language.

After selecting the language, the register is initialized. According to the displayed instruction, perform the setting.

Setting the Date and Time

1. Display the "DATE/TIME setting".
2. Enter the date in 6 digits. For example, enter "050611" for June 5, 2011.
3. Press the \square key to select the time setting.
4. Enter the time in 4 digits. For example, enter "1430" for 2:30pm.
5. Press the \square key to set the date and time.

Setting the Tax Rate

1. Select the tax number (1 to 4) to set the tax rate.
 2. Enter the tax rate in 7 digits (leading zeros may be omitted). For example, press the "7" key to set 7%.
 3. To set the second and later tax rates, press the \square key.
 4. Press the \square key to set the tax rate.
- For details, refer to "FULL DETAILED INSTRUCTION MANUAL".

Calculation of VAT rate

VAT is included in the entered price, and the tax amount is calculated when tendered according to the VAT rate programmed. By default, VAT1 is assigned to all items.

The HELP function instructs you how to assign VAT to department. After pressing the "7" key, press the \square key to access the HELP.

Setting the Mode Pass Code

1. Select the mode to set the pass code using the \square or \square keys.
2. Enter the code in 4 digits using the numeric keys.
3. Press the \square key to set the mode pass code. If no pass code is set, press the \square key.

Setting the Manager Pass Code

1. Enter the code in 4 digits using the numeric keys.
2. Press the \square key to set the manager pass code. If no pass code is set, press the \square key.

Setting the Receipt Logo

1. To change the default logo text, press the \square key to delete the texts in each line. Enter the text using the character keys to print on the receipt.
2. Press the \square key to set the receipt logo.

Text entry method

For XE-A207W/XE-A207B

There are two ways for programming text; using character keys on the keyboard or entering character codes with numeric keys on the keyboard. You can enter characters according to the small figures printed in the lower position of the numeric keys. For the layout, please refer to "keyboard Layout" for XE-A207W/XE-A207B. For example to enter "A", press the 8 key. To enter "B", press the 8 key twice.

For XE-A217W/XE-A217B

There are two ways for programming text; using character keys (on the programming key sheet) or entering character codes with numeric keys on the keyboard. To enter numerals, letters and symbols, simply press the corresponding character on the programming key sheet.

For the layout, please refer to "FULL DETAILED INSTRUCTION MANUAL".

- For details of the receipt logo, refer to "FULL DETAILED INSTRUCTION MANUAL".
- The HELP function instructs you how to set the logo message. After entering "13", press the \square key to access the HELP.

Installing Batteries

Batteries must be installed in the cash register to prevent data and programmed contents from being lost from the memory in case of accidental disconnection of the AC cord or power failure. Please install two new LR6 ("AA" size) batteries before programming and operating the cash register.

1. Remove the printer cover.



2. Open the battery cover next to the paper roll cradle.
3. Install two new LR6 ("AA" size) batteries.

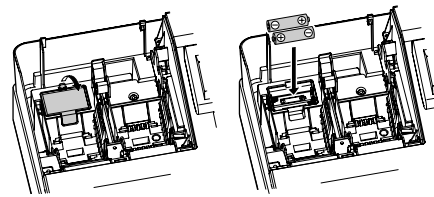

4. Close the battery cover.
5. Replace the printer cover.

Installing a Paper Roll

Always install the paper roll even when you set the register for not printing receipt in REG mode.

1. Remove the printer cover.
2. Lift up the print roller arm.

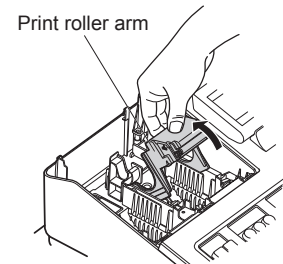

3. Set the paper correctly in the paper roll cradle.

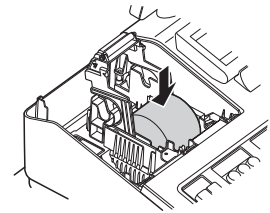

NOTE Before placing a new paper roll in the paper roll cradle, cut off the pasted (taped) part of the paper and confirm that the cut end of the paper is straight.



4. Feed the end of the paper along with the paper positioning guides as per the diagram.
5. While holding down the paper, slowly close the print roller arm.

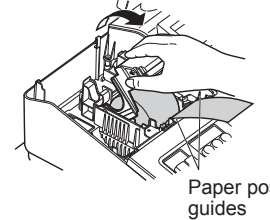

NOTE If the print roller arm is not securely locked, printing is not done right. If this problem occurs, open the arm, and close the arm as instructed above.

6. Cut off the excess paper and replace the printer cover.

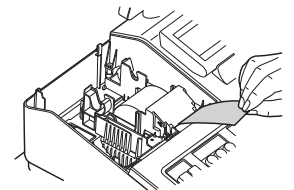

7. Press the \square key to make sure the paper end comes out of the printer cover and clean paper appears.

NOTE If the paper end does not come out, open the printer cover, and pass the paper end between the paper cutter and the paper guide of the printer cover, and replace the printer cover.

Entries

Basic Sales Entry

Listed below is a basic sales entry example when selling items by cash. For details, refer to "FULL DETAILED INSTRUCTION MANUAL".

1. Enter the clerk code and press the \square key. By default, the clerk 1 is signed on.
2. Enter the unit price and press the appropriate department key. For details, refer to the item below.
3. Repeat step 2 for all department items.
4. When the item entry is completed, press the \square key. The total amount due is displayed.
5. Receive the amount from your customer, and enter the amount by the numeric keys.
6. Press the \square key. The change due is displayed, and the drawer is opened.
7. Close the drawer.

Key operation example

Clerk assignment	→	1	\square
Item entries		1500	\square *
		2300	\square *
Displaying subtotal	→		\square /TM/ST
Amount tendered	→	4000	
Finalizing the transaction	→		\square

* \square \square : indicate department keys.

Department Entries

The register provides a maximum of 99 departments for a merchandise classification. Group attributes, such as taxable status, are applied to items when they are entered to the departments.

For XE-A207W/XE-A207B

- A) For the department 1 to 16, enter the unit price and press the department key. If you use the programmed unit price, press the department key only.
- B) For department 17 to 32, enter the unit price, press the \square key and press the department key. If you use the programmed unit price, press the \square key and press the department key.

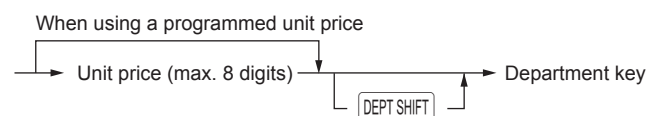

- C) For department 33 and above, enter the department code using the numeric keys and press the \square key, then enter the unit price and press the \square key. If you use the programmed unit price, enter the department code and press the \square key.

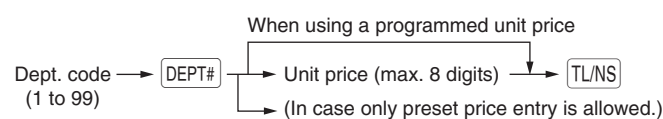

For XE-A217W/XE-A217B

- A) For the department 1 to 6, enter the unit price and press the department key. If you use the programmed unit price, press the department key only.

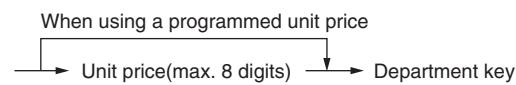

- B) For department 7 and above, enter a department code using the numeric keys and press the \square key, then enter the unit price and press the \square key. If you use the programmed unit price, enter a department code and press the \square key.

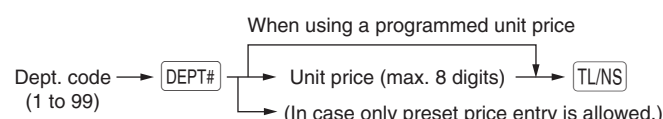

Correction

Correction of Entered Number

When you enter an incorrect number, delete it by pressing the \square key immediately after the entry.

Correction of the Last Entry

If you make a mistake when making a department entry, PLU entry, percentage \square and discount \square , you can correct this entry by pressing the \square key immediately.

Correction of Earlier Entries

You can correct any incorrect entry made during a transaction if you find it before finalizing the transaction by pressing the \square key.

Move the cursor to the item to be voided and press the \square key.

Subtotal Void

You can void an entry transaction. Once subtotal void is executed, the transaction is aborted and the register issues an receipt.

Press the \square key immediately after pressing the \square key.

And then press the \square key again.

Correction of Incorrect Entries Not Handled by the Direct, Indirect or Subtotal Void Function

Any errors found after the entry of a transaction has been completed or during an amount tendered entry cannot be voided. These errors must be handled by the manager.

The following steps should be taken.

1. If you are making the amount tendered entry, finalize the transaction.
2. Make correct entries from the beginning.
3. Hand the incorrect receipt to your manager for its cancellation.

PLU (Price Look Up) Entry

The PLU function allows speedy key entries. The cash register allows you two ways of entering PLUs; PLU Code Entry and Direct PLU Entry.

PLU Code Entry

Enter the PLU code using the numeric keys, and press the \square key. For example, enter "71" and press the \square key for "PLU 00071".

Direct PLU Entry (For XE-A217W/XE-A217B only)

Enter the assigned PLU code using the direct PLU keys provided in the keyboard. Here you can simply press the assigned direct PLU keys. The price assigned to the selected PLU code is displayed on the screen. The direct PLU keys are the numerical keys (1-70) arranged on the right side of the keyboard. For specifically which keys can be assigned as the direct PLU keys, refer to "FULL DETAILED INSTRUCTION MANUAL".

NOTE The direct PLU entry function is available only for XE-A217W/XE-A217B.

Error Warning

In the following examples, your register will go into an error state accompanied with a warning beep and the error message on the display. Clear the error state by pressing the \square key and then take the proper action to remedy the problem.

- When you exceed a 32-digit number (entry limit overflow):
Cancel the entry and re-enter a correct number.
- When you make an error in key operation:
Clear the error and try the entry again.
- When you make an entry beyond a programmable amount entry limit:
Check to see if the entered amount is correct. If it is correct, it can be rung up in the MGR mode. Contact your manager.
- When an including-tax subtotal exceeds eight digits:
Clear the error message by pressing the \square key and then press a media key to finalize the transaction.

Reading and Resetting Sales

List of All Available Report

- Use the reading function (X) when you need to take the reading of sales information entered after the last resetting. You can take this reading any number of times. It does not affect the register's memory.
- Use the resetting function (Z) when you need to clear the register's memory. Resetting prints all sales information and clears the entire memory except for the GT1 through GT3, reset count, and consecutive number.
- X1 and Z1 reports show daily sales information. You can take these reports in the X1/Z1 mode.
- X2 and Z2 reports show periodic (monthly) consolidation information. You can take these reports in the X2/Z2 mode.
- In the OP X/Z mode, an clerk can take his or her report.
- If you want to stop the printing report, press the **[ESC/CANCEL]** key.

Item	Mode					
	OP X/Z		X1/Z1		X2/Z2	
	X	Z	X	Z	X	Z
General report			○	○	○	○
PLU report by designated range			○	○		
PLU report by associated department			○	○		
Individual clerk report	○	○	○	○		
All clerk report			○	○		
Hourly report			○	○		
GLU report *			○	○		
GLU report by clerk*			○	○		
Balance report *			○			
Flash report			○			

*: For XE-A217W/XE-A217B only



- When both sales quantities and sales amounts are zero, printing is skipped. If you do not want to skip, change the programming. For details, refer to "FULL DETAILED INSTRUCTION MANUAL".
- "X" represents read symbol and "Z" represents reset symbol in the reports.
- The drawer does not open when you take X/Z reports.
- When printing is performed continuously, the printing may be intermitted for several seconds. After the intermission, the printing will be restarted.

How to take a X1/Z1 or X2/Z2 report

[To take an X1 or X2 report:]

- Press the **[MODE]** key.
- Select the "4 X1/Z1 MODE" or "5 X2/Z2 MODE" by using the **[↓]** key, and press the **[TUNES]** key.
- Select "2 READING" in the X1/Z1 mode or select "1 READING" in the X2/Z2 mode menu window and press in both cases the **[TUNES]** key to display the items list.
- Select the appropriate report title.
- Press the **[TUNES]** key.

[To take a Z1 or Z2 report:]

- Press the **[MODE]** key.
- Select the "4 X1/Z1 MODE" or "5 X2/Z2 MODE" by using the **[↓]** key, and press the **[TUNES]** key.
- Select "3 RESETTING" in the X1/Z1 mode or select "2 RESETTING" in the X2/Z2 mode menu window and press in both cases the **[TUNES]** key to display the items list.
- Select the appropriate report title.
- Press the **[TUNES]** key.

Flash report

You can take flash reports (display only) in the X1 mode for department sales, cash in drawer (CID) and sales total at the point you take the report.

- Press the **[MODE]** key.
- Select "1 FLASH READ" in the X1/Z1 mode menu window and press the **[TUNES]** key to display the items list.
- Select "DEPT. SALES" to take a flash report of department sales, "CID" to take a flash report of cash in drawer, or "SALES TOTAL" to take a flash report of sales total.

Main Functional Overview

The register has the following main functions. For details, refer to "FULL DETAILED INSTRUCTION MANUAL".

Item Entries

- Single item entries
- Repeat entries
- Multiplication entries
- Split-pricing entries
- Single item cash sale (SICS) entries

Special Entries for PLU

- PLU entries
- Direct PLU entries (For XE-A217W/XE-A217B only)

Display of Subtotals

- Subtotal

Finalization of Transaction

- Cash or check sale that does not need any tender entry
- Credit sale
- Mixed sales and tender entries

Computation of VAT (Value Added Tax)/Tax

- VAT/tax system
- VAT surcharge system
- VAT shift entries (For XE-A217W/XE-A217B only)

Guest Check (GLU)

- Guest look up (GLU) system (For XE-A217W/XE-A217B only)

Auxiliary Entries

- Refund entries
- Percentage discount
- Amount discount
- Non-add code entry

Payment Treatment

- Currency exchange
- Received-on-account entries
- Paid-out entries
- No-sale (exchange)
- Cashing a check

Correction

- Correction of the last entry (direct void)
- Correction of the next-to-last or earlier entries (indirect void)
- Subtotal void
- Correction of incorrect entries not handled by the direct, indirect or subtotal void function

Special Printing Function

- Copy receipt printing
- Bill printing

Manager Mode

- Manager sign-on
- Override entries

Other Functions

- Training mode
- SD card mode
- Electronic journal
- Electronic journal data view function

Reports

- General report
- Transaction report
- Department report
- PLU report
- Hourly report
- Clerk report (All/Individual)
- GLU (For XE-A217W/XE-A217B only)
- Balance (For XE-A217W/XE-A217B only)
- Electric Journal (Search)
- Flash reports
- Euro change

Maintenance

Batteries

This register displays a low battery warning message "LOW BATTERY" when the batteries are low, and displays a no battery warning message "NO BATTERY" when batteries are extremely low or batteries are not installed.

If no batteries are installed, install two new alkaline batteries LR6 ("AA" size) at once. If batteries are already installed, replace them with new ones as soon as possible. If the AC power cord is disconnected or a power failure occurs when the batteries are dead or not installed, all the programmed settings will be reset to the default settings and any data stored in memory will be cleared.



Improper use of batteries could cause them to burst or leak, which might damage the interior of the register. Please take the following precautions:

- Be sure that the positive (+) and negative (-) poles of each battery are oriented properly.
- Never mix batteries of different types.
- Never mix old batteries and new ones.
- Never leave dead batteries in the battery compartment.
- Remove the batteries if you plan not to use the register for long periods.
- Should a battery leak, clean out the battery compartment immediately, taking care not to let the battery fluid come into direct contact with your skin.
- If an incorrect battery is used, it may explode or leak.
- For battery disposal, follow the relevant law or regulation in your country.

Replacement

- Be sure the register is plugged in.
- Remove the printer cover.



- Open the battery cover and remove the old batteries.

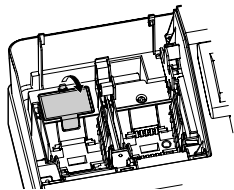

- Install two new LR6 ("AA" size) batteries into the battery compartment.

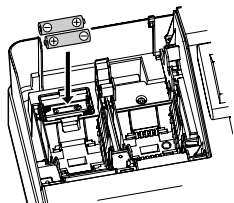

- Close the battery cover.
- Replace the printer cover.

Paper Roll

When colored dye appears on the edges of the paper roll, it is time to replace the paper roll. Use paper of 57.5 ± 0.5 mm in width. To prevent jamming be sure to use paper specified by SHARP.

Replacement

- Confirm that the REG mode has been selected.
- Remove the printer cover.
- Lift up the print roller arm.
- Remove the remaining paper roll.
- Install a new paper roll correctly by following the steps in "Installing a Paper Roll".

Removing a Paper Jam



The paper cutter is mounted on the printer cover. Be careful not to cut yourself. Never touch the print head immediately after printing, as the head may still be hot.

- Remove the printer cover.
- Lift up the print roller arm.
- Remove the paper jam. Check for and remove any shreds of paper that may remain in the printer.
- Reset the paper roll correctly by following the steps in "Installing a Paper Roll".

Installing the Fixing Angle Bracket

To prevent the register from moving when the drawer opens, the fixing angle bracket is supplied with the register. By attaching the bracket to the table where the register is installed, you can hook the register on this bracket and secure the register to its position.

How to install the fixing angle bracket

- Thoroughly clean the location where the fixing angle bracket (B) is to be placed.
- Peel off the adhesive tape on the fixing angle bracket.
- Hook the angle bracket onto the hook (A) that is located at the bottom rear of the register.
- Firmly stick the fixing angle bracket to the table surface that you cleaned above.

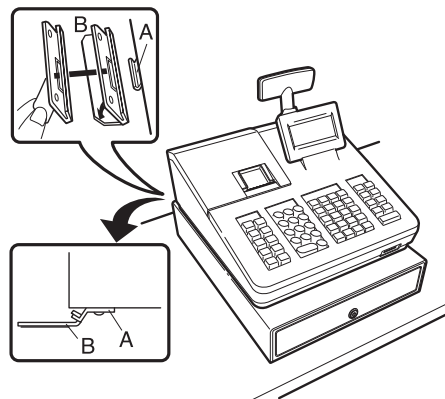

How to remove the register from the fixing angle bracket

Lift up the front of the register and pull the register towards you.

Drawer Handling

Locking the Drawer

Develop the habit of locking the drawer when not using the register for any extended period of time.

- To lock:** Insert the key into the drawer lock and turn it 90 degrees counter-clockwise.
- To unlock:** Insert the key into the drawer lock and turn it 90 degrees clockwise.

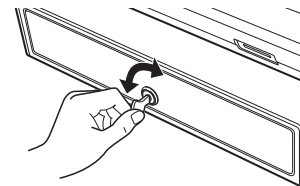

Removing the Drawer

To remove the drawer, pull it out and lift it up.

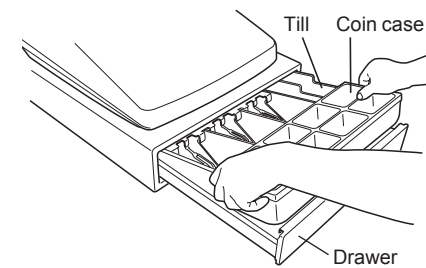

- To prevent burglary, it is a good idea to empty the drawer after work and leave it open at the end of the day.
- Coin case is detachable.

Manually Opening the Drawer

In case of a power failure or if the machine is out of order, locate the lever at the bottom of the machine and move it in the direction of the arrow to open the drawer. The drawer will not open if it is locked with the drawer lock key.

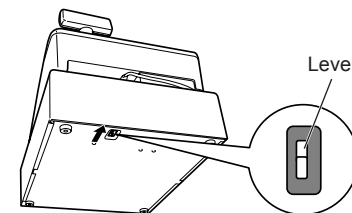

Warning

This is a Class A product. In a domestic environment this product may cause radio interference in which case the user may be required to take adequate measures.

Achtung

Dies ist ein Gerät der Klasse A. Dieses Gerät kann im Wohnbereich Funkstörungen verursachen; in diesem Fall kann vom Betreiber verlangt werden, angemessene Gegenmaßnahmen durchzuführen und dafür aufzukommen.

Advertencia

Este es un producto de la clase A. En un ambiente doméstico es posible que este producto cause radiointerferencia. En este caso se solicita al usuario que tome medidas adecuadas.

Avvertência

Este é um produto de classe A. Num ambiente doméstico este produto pode causar interferência rádio sendo que neste caso o utilizador terá que tomar medidas adequadas.

Avertissement

Ceci est un produit de Classe A. Dans un environnement domestique ce produit risque de provoquer une interférence radio, auquel cas l'utilisateur sera obligé d'observer les mesures adéquates.

Waarschuwing

Dit is een Klasse A-product. Het is mogelijk dat dit product in de huiselijke omgeving radiostoringen veroorzaakt waartegen de gebruiker afdoende maatregelen dient te nemen.

Avvertenza

Questo è un prodotto di Classe A. In un ambiente domestico questo prodotto può causare interferenze radio, nel qual caso l'utilizzatore può essere tenuto a prendere provvedimenti adeguati.

Advarsel

Dette er et klasse A produkt. I et hjemligt miljø kan produktet forårsage radio forstyrrelser, hvor brugeren kan være forpligtet til at træffe passende foranstaltninger.

Advarsel

Dette er et klasse A produkt. Innendørs kan dette produktet skape radioforstyrrelser. I så tilfelle må brukeren iverksette nødvendige tiltak.

Varoitus

Tämä on luokan A tuote. Kotiympäristössä tämä tuote saattaa aiheuttaa radiohäiriötä, jossa tapauksessa käyttäjän on ehkä ryhdyttävä tarvittaviin toimenpiteisiin.

Varning

Detta är en produkt av klass A. I hemmiljö kan produkten störa radiomottagning, i vilket fall användaren kan behöva vidta motåtgärder.

Varování

Toto je výrobek třídy A. Je-li výrobek provozován v domácím prostředí, může způsobovat radiové rušení jiných zařízení a uživatel proto musí provést odpovídající opatření.

Upozorenje

Ovo je proizvod A klase. U domaćem okruženju ovaj proizvod može prouzročiti radio smetnje što može zahtijevati od korisnika da poduzme odgovarajuće mjere.

Varovanie

To je proizvod razreda A. V domaćem okolju lahko ta izdelek povzroči radijske motnje. V tem primeru mora uporabnik ustrezno ukrepati.

Hoiatus

Tegemist on A-klassi tootega. Kodukeskkonnas kasutamisel võib antud toode põhjustada raadiointerferentsi, mis omakorda nõuab kasutajalt sobivate meetmete rakendamist.

Προειδοποίηση

Αυτό είναι ένα προϊόν κατηγορίας Α. Σε ένα εσωτερικό περιβάλλον αυτό το προϊόν μπορεί να προκαλέσει τη ραδιο ακτινοβολία. Σε αυτή την περίπτωση ο χρήστης πρέπει να λάβει επαρκή μέτρα προστασίας.

Uwaga

Urządzenie to jest urządzeniem klasy A. W środowisku mieszkalnym może ono powodować zakłócenia radioelektryczne. W takich przypadkach można żądać od użytkownika zastosowania odpowiednich środków zaradczych.

Upozorenje

Ovo je proizvod klase A. U kućnom okruženju ovaj proizvod može prouzrokovati radio smetnje, u tom slučaju od korisnika se zahteva da preduzme odgovarajuće mere.

CAUTION:

The cash register should be securely fitted to the supporting platforms to avoid instability when the drawer is open.

CAUTION:

The socket-outlet shall be installed near the equipment and shall be easily accessible.

VORSICHT:

Die Netzsteckdose muß nahe dem Gerät angebracht und leicht zugänglich sein.

ATTENTION:

La prise de courant murale devra être installée à proximité de l'équipement et devra être facilement accessible.

AVISO:

El tomacorriente debe estar instalado cerca del equipo y debe quedar bien accesible.

WARNING:

Det matande vägguttaget skall placeras nära apparaten och vara lätt åtkomligt.

LET OP:

Het stopcontact dient in de buurt van de kassa en gemakkelijk toegankelijk te zijn.

CAUTION:

For a complete electrical disconnection pull out the mains plug.

VORSICHT:

Zur vollständigen elektrischen Trennung vom Netz den Netzstecker ziehen.

ATTENTION:

Pour obtenir une mise hors-circuit totale, débrancher la prise de courant secteur.

AVISO:

Para una desconexión eléctrica completa, desenchufar el enchufe de tomacorriente.

WARNING:

För att helt koppla från strömmen, dra ut stickproppen.

LET OP:

Trek de stekker uit het stopcontact indien u de stroom geheel wilt uitschakelen.

Shielded interface cables must be used with this equipment to maintain compliance with EMC regulations.

Before Calling for Service

If you encounter any of the following problems, please read below before calling for service.

The display does not illuminate.

- Is power supplied to the electric outlet?
- Is the power cord plug out or loosely connected to the electric outlet?
- Is the terminal in screen-save mode?

The display is illuminated, but the whole machine refuses entries.

- Is a clerk code assigned to the register?
- Is the register in the REG mode?

No receipt is issued.

- Is the receipt paper roll properly installed?
- Is there a paper jam?
- Is the receipt function in the "OFF" status?
- Is the print roller arm securely locked?

Printing is unusual.

- Are the print head/sensor/roller clean?
- Is the paper roll properly installed?

Specifications**Model:**

XE-A207W/XE-A207B
XE-A217W/XE-A217B

Dimensions:

360(W) × 425(D) × 330(H) mm

Weight:

Approx. 11.0kg

Power source:

Official (nominal) voltage and frequency

Power consumption:

Standby: 7.4W (220 to 230V, 50Hz/60Hz)
7.5W (230 to 240V, 50Hz)

Operating: 32.4W (220 to 230V, 50Hz/60Hz)

32.2W (230 to 240V, 50Hz)

Working temperatures:

0 to 40 °C

Display:

Operator display: LCD display with tilt mechanism
160(W) × 64(H) dots

Customer display: 7-segment LED display

Printer:**Type:**

One-station thermal printer

Printing speed:

Approx. 12 lines/second

Printing capacity:

30 digits

Other functions:

- Receipt (ON-OFF) function
- Compression print for an electronic journal

Logo:**Graphic logo printing:**

size: 130(H) × 360(W)pixel
Area of black must be less than 35% of all area.

Logo message printing:

Logo message for the receipt (max. 30 characters × 6 lines)

Paper Roll:

Width: 57.5±0.5 mm

Max. diam.: 80 mm

Quality: High quality (0.06 to 0.08 mm thickness)

Cash drawer:

5 slots for bills and 8 for coin denominations

Accessories:

Basic User Manual: 1 copy

Standard key sheet: 1 (placed under keyboard cover) for XE-A217W/XE-A217B only

Programming key sheet: 1(placed under keyboard cover) for XE-A217W/XE-A217B only

Paper roll: 1 roll

Drawer lock key: 2

Fixing angle bracket: 1

Battery caution label: 1

FOR CUSTOMERS IN U.K.**IMPORTANT**

The wires in this mains lead are coloured in accordance with the following code:

BLUE:	Neutral
BROWN:	Live

As the colours of the wires in the mains lead of this apparatus may not correspond with the coloured markings identifying the terminals in your plug proceed as follows.

The wire which is coloured BLUE must be connected to the terminal which is marked with the letter N or coloured black.

The wire which is coloured BROWN must be connected to the terminal which is marked with the letter L or coloured red.

The apparatus must be protected by a 3A fuse in the mains plug or distribution board.

CAUTION: DO NOT CONNECT THE LIVE (BROWN) WIRE OR THE NEUTRAL (BLUE) WIRE TO THE EARTH TERMINAL OF YOUR 3-PIN MAINS PLUG.

Noise level LpA: 60,7 dB(A-weighted)

Measured according to EN ISO 7779:2001

[Maximum value if the cash drawer springs open LpA: 80,4 dB(A-weighted)]

Authorized representative responsible for the European Union Community Market.

Autorisierter Repräsentant in der Europäischen Union.

Représentante autorisé pour le marché de la communauté européenne.

Representante autorizado responsable para el Mercado Común de la Unión Europea.

Auktoriserad representant ansvarig för EU marknaden.

Geautoriseerde vertegenwoordiger in de Europese Unie.

SHARP

SHARP ELECTRONICS (Europe) GmbH

Sonninstraße 3, D-20097 Hamburg

SHARP CORPORATION