

# SHARP®

ELECTRONIC CASH REGISTER

MODEL

**XE-A137**

**XE-A147**

FULL DETAILED INSTRUCTION MANUAL



**CAUTION:**

The cash register should be securely fitted to the supporting platform to avoid instability when the drawer is open.

**CAUTION:**

The socket-outlet shall be installed near the equipment and shall be easily accessible.

**VORSICHT:**

Die Netzsteckdose muß nahe dem Gerät angebracht und leicht zugänglich sein.

**ATTENTION:**

La prise de courant murale devra être installée à proximité de l'équipement et devra être facilement accessible.

**AVISO:**

El tomacorriente debe estar instalado cerca del equipo y debe quedar bien accesible.

**WARNING:**

Det matande vägguttaget skall placeras nära apparaten och vara lätt åtkomligt.

**LET OP:**

Het stopcontact dient in de buurt van de kassa en gemakkelijk toegankelijk te zijn.

**CAUTION:**

For a complete electrical disconnection pull out the AC adapter.

**VORSICHT:**

Zur vollständigen elektrischen Trennung vom Netz den AC Adapter.

**ATTENTION:**

Pour obtenir une mise hors-circuit totale, débranchez l'adaptateur secteur.

**AVISO:**

Para una desconexión eléctrica completa, desenchufar el adaptador de CA.

**WARNING:**

För att helt koppla från strömmen, dra ut nätadaptern.

**LET OP:**

Maak de netspanningsadapter los om de stroomtoevoer volledig uit te schakelen.

---

# INTRODUCTION

Thank you very much for your purchase of the SHARP Electronic Cash Register, Model XE-A137/XE-A147. Please read this manual carefully before operating your machine in order to gain full understanding of functions and features.

Please keep this manual for future reference. It will help you if you encounter any operational problems.

## CAUTION!

**Never install the batteries into the cash register before initializing it.** Before you start operating the cash register, you must first initialize it, then install three new alkaline batteries LR6 ("AA" size) on the register. Otherwise, distorted memory contents and malfunction of the cash register will occur. For this procedure, please refer to pages 7 to 8.

---

# IMPORTANT

- **Be very careful when removing and replacing the printer cover, as the cutter mounted on it is very sharp.**
- **Install the cash register in a location not subject to direct sunlight, unusual temperature changes, high humidity, splashing water or dust and sand.**  
Installation in such locations could cause damage to the cabinet, the electronic components and other precision components.
- **Never operate the register with wet hands.**  
The water could seep into the interior of the register and cause component failure.
- **When cleaning your register, use a dry, soft cloth. Never use solvents, such as benzine and/or thinner.**  
The use of such chemicals will lead to discoloration or deterioration of the cabinet.
- **The register plugs into any standard wall outlet (official (nominal) voltage).**  
Other electrical devices on the same electrical circuit could cause the register to malfunction.
- **For protection against data loss, please install three alkaline batteries LR6 ("AA" size) after initializing the cash register. When handling the batteries, please observe the following:**  
Incorrectly using batteries can cause them to burst or leak, possibly damaging the interior of the cash register.
  - **RISK OF EXPLOSION IF BATTERY IS REPLACED BY AN INCORRECT TYPE.**  
**DISPOSE OF USED BATTERIES ACCORDING TO THE INSTRUCTIONS.**
  - **Be sure that the positive (+) and negative (-) poles of each battery are facing in the proper direction for installation.**
  - **Never mix batteries of different types.**
  - **Never mix old batteries and new ones.**
  - **Never leave dead batteries in the battery compartment.**
  - **Remove the batteries if you do not plan to use the cash register for long periods.**
  - **Should a battery leak, clean out the battery compartment immediately, taking care to avoid letting the battery fluid come into direct contact with your skin.**
  - **For battery disposal, follow the corresponding law in your country.**
- **For complete electrical disconnection, disconnect the AC adapter.**
- **Be sure to use the attached AC adapter. Otherwise, an electric shock or fire may be caused.**

---

# CONTENTS

<b>INTRODUCTION</b> .....	<b>1</b>
<b>IMPORTANT</b> .....	<b>1</b>
<b>CONTENTS</b> .....	<b>2</b>
<b>PARTS AND THEIR FUNCTIONS</b> .....	<b>4</b>
1 External View .....	4
2 Printer .....	4
3 Mode Switch and Mode key .....	5
4 Keyboard .....	5
5 Display .....	6
6 Drawer Lock Key .....	6
<b>PREPARING THE CASH REGISTER</b> .....	<b>7</b>
1 Initializing the Cash Register .....	7
2 Installing Batteries .....	8
3 Installing a Paper Roll .....	9
<b>HELP FUNCTION</b> .....	<b>10</b>
<b>BASIC FUNCTION PROGRAMMING</b> .....	<b>11</b>
1 Abbreviations and Terminology .....	11
2 Prior to Programming .....	11
3 Language Selection .....	13
4 Date and Time Programming .....	13
5 Tax Programming .....	14
6 Department Programming .....	15
7 PLU (Price Look-Up) and Subdepartment Programming .....	18
8 Text Programming .....	20
<b>BASIC SALES ENTRY (Example)</b> .....	<b>22</b>
1 Basic Sales Entry .....	22
2 PLU Sales Entry .....	23
<b>CORRECTION</b> .....	<b>24</b>
1 Cancellation of the Numeric Entry .....	24
2 Correction of the Last Entry (direct void) .....	24
3 Correction of the Next-to-last or Earlier Entry (indirect void) .....	25
4 Subtotal Void .....	25
5 Correction after Finalizing a Transaction (Void mode) .....	26
<b>FULL SALES REPORT (X or Z REPORT)</b> .....	<b>27</b>
<b>OTHER BASIC SALES ENTRIES</b> .....	<b>29</b>
1 Additional Information for BASIC SALES ENTRY .....	29
2 Error Warning .....	29
3 Starting Cash Memory (SCM) Entry .....	30
4 Item Entries .....	31
5 Display of Subtotal .....	34
6 Finalization of Transaction .....	35
7 Computation of VAT (Value Added Tax)/Tax .....	37
<b>OPTIONAL FEATURES</b> .....	<b>39</b>
1 Auxiliary Entries .....	39
2 Auxiliary Payment Treatment .....	40
3 Special Printing Function .....	42
<b>PRIOR TO PROGRAMMING</b> .....	<b>43</b>
<b>AUXILIARY FUNCTION PROGRAMMING</b> .....	<b>45</b>
1 Miscellaneous Key Programming .....	45
2 Other Text Programming .....	49

<b>ADVANCED FUNCTION PROGRAMMING .....</b>	<b>52</b>
1 Register Number and Consecutive Number Programming .....	52
2 Various Function Selection Programming 1.....	53
3 Various Function Selection Programming 2.....	61
4 EURO Programming.....	63
5 Reading Stored Programs .....	66
<b>READING (X) AND RESETTING (Z) OF SALES TOTALS.....</b>	<b>68</b>
1 Summary of Reading (X) and Resetting (Z) Reports.....	68
2 Daily Sales Totals .....	69
<b>EJ REPORT READING AND RESETTING.....</b>	<b>70</b>
<b>EURO MIGRATION FUNCTION.....</b>	<b>71</b>
<b>SD CARD FUNCTION.....</b>	<b>74</b>
<b>OPERATOR MAINTENANCE .....</b>	<b>76</b>
1 In Case of Power Failure .....	76
2 In Case of Printer Error.....	76
3 Cautions in Handling the Printer and Recording Paper.....	76
4 Replacing the Batteries.....	77
5 Replacing the Paper Roll.....	78
6 Removing a Paper Jam .....	79
7 Cleaning the Printer (Printer Head / Sensor / Roller).....	79
8 Removing the Drawer .....	80
9 Opening the Drawer by Hand .....	80
<b>BEFORE CALLING FOR SERVICE.....</b>	<b>81</b>
<b>SPECIFICATIONS .....</b>	<b>82</b>

# PARTS AND THEIR FUNCTIONS

## 1 External View

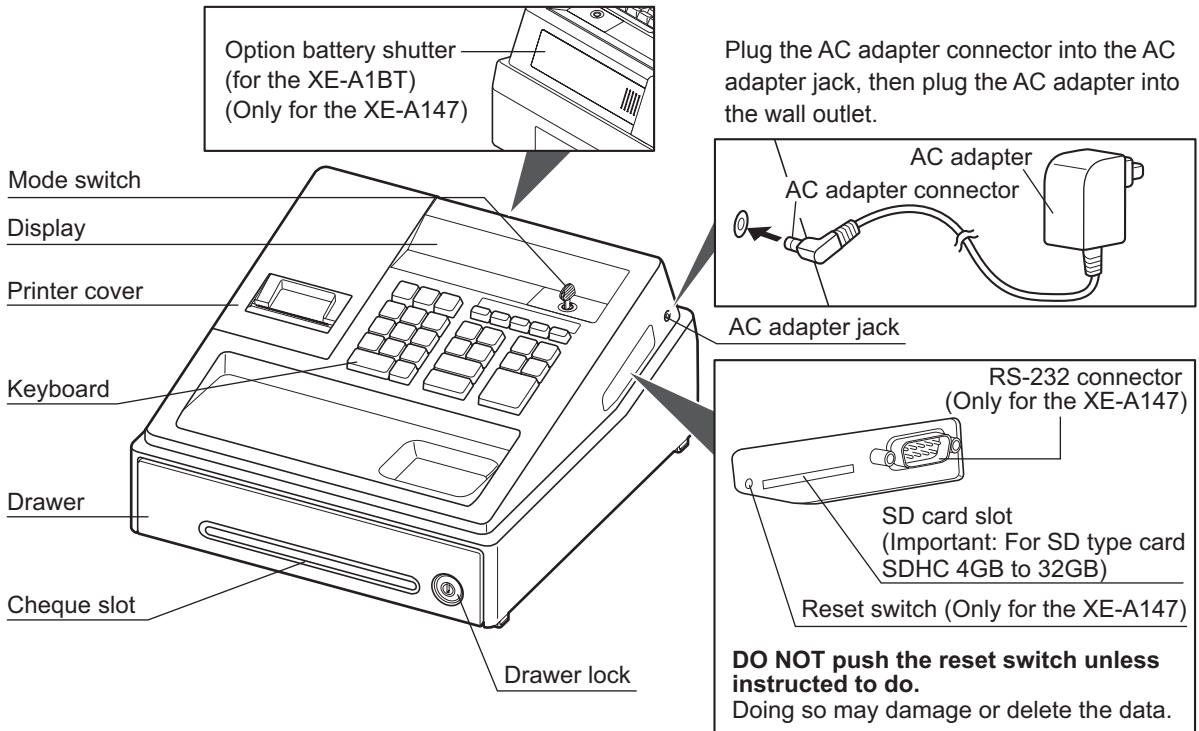

## 2 Printer

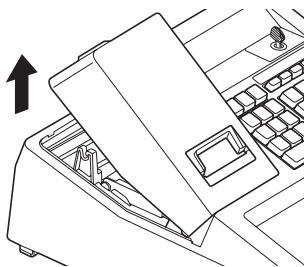

The printer is a receipt (one station) type thermal printer, and therefore it does not require any type of ink ribbon or cartridge. The average life of the printer is approximately 5 million lines.

When removing the printer cover, lift up its rear.

When installing the printer cover, hook it on the pawls on the cabinet and shut it.

**Caution:**The paper cutter is mounted on the printer cover. Be careful not to cut yourself.

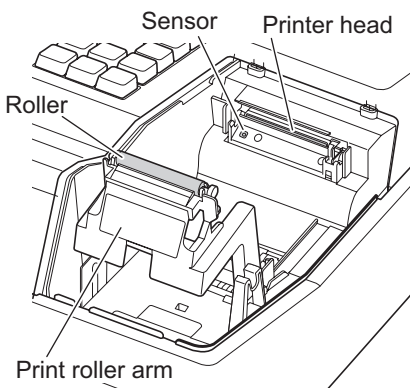

### NOTE

Do not attempt to remove the paper with the print roller arm in the hold position. This may result in damage to the printer and printer head.

### 3 Mode Switch and Mode key

Insert the mode key (the same key as drawer lock key) into the mode switch and move the key to get an appropriate mode.

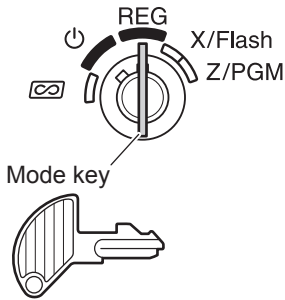

- ⏻:** Turns the display off. No operations are possible.
- REG:** Permits transaction entry.
- ∞:** Permits correction after finalizing a transaction.
- X/Flash:** Permits printing of sales reports and displaying the flash reports.
- Z/PGM:** Permits printing and resetting of sales reports and programming.

### 4 Keyboard

#### Keyboard layout

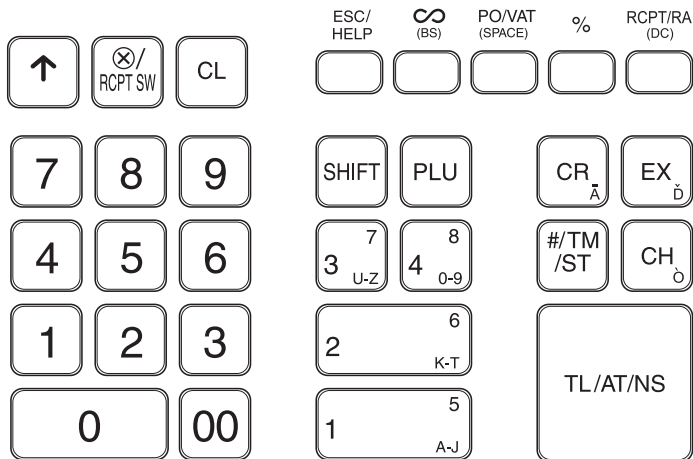

#### Key names

	Paper feed key		PLU/Subdepartment key		Total/Amount tender/No sale key
	Multiplication/receipt switch key		Department keys		Void key
	Clear key		Credit key		Escape/Help key
	Numeric keys		Foreign currency exchange key		Percent key
			Non-add code/Time display/Subtotal key		Paid-out/Value added tax key
	Shift key		Cheque key		Receipt print/Received-on-account key

## 5 Display

### Operator display

Your cash register is equipped with a front LED (Light-Emitting Diode) display that affords easy visibility of 9 digits for the operator during transaction.

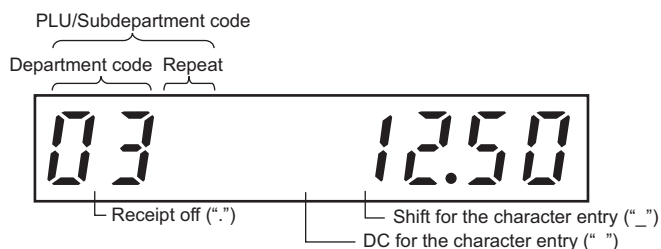

**Amount:** Appears in the far-right eight (max.) positions. When the amount is negative, the minus symbol “-” appears before the amount.

**Number of repeats for repetitive registrations:**

The number of repeats is displayed, starting at “2” and incremental with each repeat. When you have registered ten times, the display will show “0”. (2 → 3 ..... 9 → 0 → 1 → 2 ... )

**Receipt function status:**

The indicator “.” appears in the receipt off position when the receipt function is in the OFF status.

**Time:** Appears in the first to fifth positions (using 24-hour format) in the REG or mode. Press the key to display the time.

### Machine state symbols

: Appears during programming.

: Appears with an error code when an error is detected. For the details of error codes, please refer to “Error code table”.

: Appears when the subtotal is displayed or when the amount tendered is smaller than the sales amount.

: Appears when the key is pressed to calculate a subtotal in foreign currency.

: Appears when a transaction is finalized by pressing the , or key.

: Appears when the change due amount is displayed.

: Appears in the far-left three positions at the timing of key entry when the electronic journal (EJ) memory is full. (Depending on programming.)

: Appears when the voltage of the installed batteries is under the required level. You must replace with new ones within two days. Refer to page 77 for details.

: Appears when the batteries are not installed, or the installed batteries are dead. You must replace with new ones immediately. Refer to page 77 for details.

- : May appear right below the seventh and eighth places at the timing of finalization of a transaction when the electronic journal (EJ) memory is nearly full.

: Appears when programmed date (and time) for EURO modification operation has come.

: Appears when the paper is not set or out.

## 6 Drawer Lock Key

This key (the same key as mode key) locks and unlocks the drawer. To lock it, turn 90 degrees counterclockwise. To unlock it, turn 90 degrees clockwise.





# PREPARING THE CASH REGISTER

Unpack the cash register and make sure all accessories are included. For details of accessories, please refer to "SPECIFICATIONS" section.

For installing the cash register, find a stable surface near an AC outlet where the cash register will not subject to water sources or direct sunlight.

For preparing the cash register, please follow the three steps shown below; "1 Initializing the Cash Register" on this page, "2 Installing Batteries" on page 8, and "3 Installing a Paper Roll" on page 9.

## 1 Initializing the Cash Register

In order to operate the cash register properly, you must initialize it before operating for the first time. Follow this procedure.

1. Insert the mode/drawer lock key into the mode switch and turn it to the REG position.
2. Insert the AC adapter into the AC outlet.  
**IMPORTANT: This operation must be performed without batteries installed.**
3. The cash register has now been initialized. The register display will show "0.00" with "L".



### NOTE

*If this does not happen when inserting the AC adapter, then the initialization has not been done successful. (This will occur when the voltage is high because you operated the cash register before starting initialization.) Wait at least one minute after pulling out the AC adapter and reinsert the AC adapter into the AC outlet only after this waiting time has passed.*

## 2 Installing Batteries

Three new alkaline batteries LR6 (“AA”size) must be installed in the cash register to prevent the data and user-programmed settings from being erased from the memory, when the AC adapter plug is accidentally disconnected or in case of power failure. Once installed, the batteries will last approximately one year before needing replacement. At this time, the “ $\text{L}$ ” symbol will appear on the display to indicate the batteries are low and must be replaced within two days. **If the no battery symbol “ $\text{L}$ ” appears, you must install the batteries at once. Install three new alkaline batteries LR6 (“AA”size) according to the procedure shown below with the AC adapter plug connected and set the mode switch to the REG position:**

1. Push the printer cover forward and detach it.  
**Be careful with the paper cutter, so as not to cut yourself.**
2. Open the battery compartment cover next to the paper roll cradle.

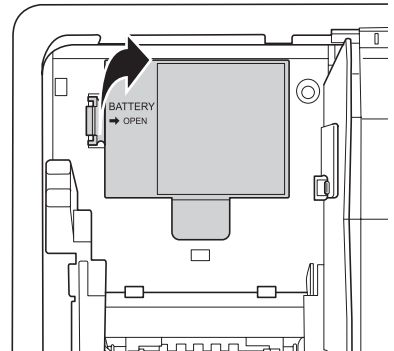

3. Install three new alkaline batteries LR6 (“AA”size) as per the diagram. When the batteries are properly installed “ $\text{L}$ ” on the display will disappear.
4. Close the battery compartment cover.

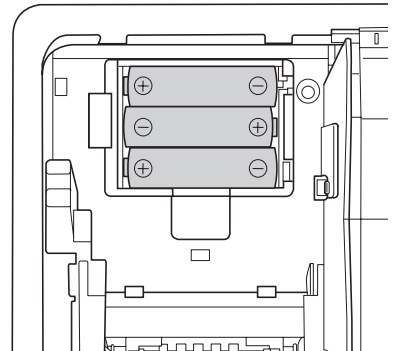

- NOTE**
- Be sure to observe precautions shown on page 1 when handling batteries.
  - If you press a key by mistake, an error symbol “PPPPPPPPPP” may be displayed. Press the  $\text{CL}$  key to clear the symbol after installing paper rolls.

**Caution:** “ $\text{L}$ ” or “ $\text{L}$ ” can be displayed only when the cash register is being turned on. Please be advised that when the cash register is being turned off for a long time, the data in memory might be cleared without the warning symbols: “ $\text{L}$ ” or “ $\text{L}$ ”.

### 3 Installing a Paper Roll

The register can print receipts. For the printer, you must install the paper roll provided with the register.

**NOTE** Install the paper roll in the printer. Be careful then to set the roll and cut the paper end correctly.

#### (How to set the paper roll)

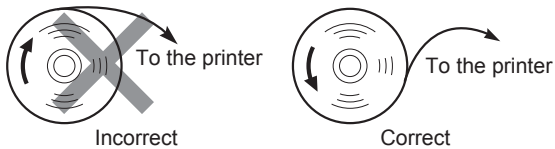

#### (How to cut the paper end)



1. Remove the printer cover.
2. Lift up the print roller arm.

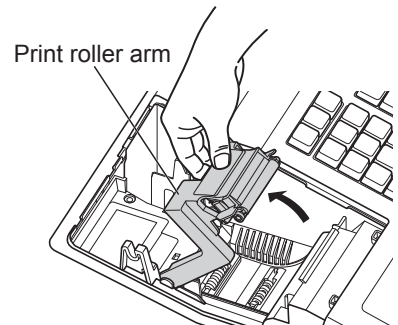

3. Set the paper correctly in the paper roll cradle as per the diagram.

**NOTE** Before placing a new paper roll in the paper roll cradle, cut off the pasted (taped) part of the paper and confirm that the cut end of the paper is straight.

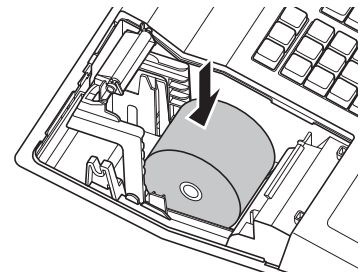

4. Feed the end of the paper along with the paper positioning guides as per the diagram.
5. While holding down the paper, slowly close the print roller arm, and push down the arm until you hear a click locking the arm.

**NOTE** If the print roller arm is not securely locked, printing is not done right. If this problem occurs, open the arm, and close the arm as instructed above.

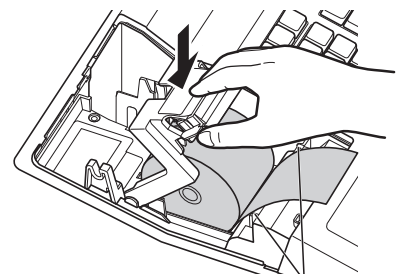

Paper positioning guides

6. Cut off the excess paper and replace the printer cover.
7. Press the  key to make sure the paper end comes out of the printer cover and clean paper appears.

**NOTE** If the paper end does not come out, open the printer cover, and pass the paper end between the paper cutter and the paper guide of the printer cover, and replace the printer cover.

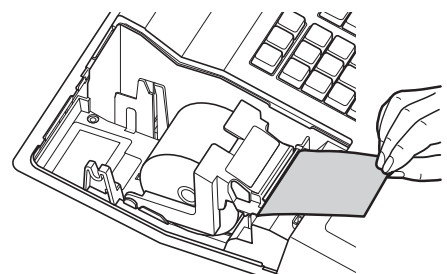

# HELP FUNCTION

The help function allows you to print guidance messages for basic programming procedures of the cash register. This function is available in any mode switch position other than “**⏻**”. For more details on each programming, refer to “BASIC FUNCTION PROGRAMMING” on pages 11 to 21.

## ■ Printing the help menu

Press the **[ESC/HELP]** key to print the help menu. This menu provides a list of the programming procedures for which you can print the guidance messages.

Key operation	Print
<b>[ESC/HELP]</b>	<pre>HELP MENU  1 LANGUAGE SELECTION 2 HOW TO SET THE PAPER 3 DATE SETTING 4 TIME SETTING 5 VAT RATE SETTING 6 VAT TEXT SETTING 7 VAT ASSIGNMENT TO DEPT. 8 DEPARTMENT TEXT SETTING 9 MINUS DEPARTMENT SETTING 10 PLU:DEPT. ASSIGNMENT/PRICE 11 PLU TEXT SETTING 12 LOGO MESSAGE SETTING 13 TEXT INPUT METHOD 14 DAILY Z REPORT PRINT 15 HOW TO SET RCPT SW OFF/ON 16 HOW TO OPERATE SD CARD  TO PRINT ABOVE EACH HELP CONTENTS. EX) 1-[ESC/HELP]. MODE POSITION REG MODE.</pre>

## ■ Printing guidance messages

By reference to the help menu above, press the corresponding numeric key and then the **[ESC/HELP]** key to print the guidance message for each programming procedure.

Key operation	Print
4 <b>[ESC/HELP]</b>	<pre>4 TIME SETTING  MODE POSITION Z/PGM MODE. [HHMM]-[#/TM/ST] HH:00-23 MM:00-59 JOB#61-F: TIME FORMAT 24 HOUR = 1 (DEFAULT) 12 HOUR = 0 EX) PM4:30 (TIME FORMAT=24 HOUR) 1630-[#/TM/ST]</pre>

Sample print of TIME SETTING

**NOTE** The **[ESC/HELP]** key works as the error escape function during a transaction. Finalize the transaction to use the key as the help function.

# BASIC FUNCTION PROGRAMMING

Before starting sales entries, you must first program necessary items so the cash register suits your sales needs. In this manual, there are three sections, **BASIC FUNCTION PROGRAMMING (pages 11-21) where required items must be programmed**, **AUXILIARY FUNCTION PROGRAMMING (pages 45-51)** for using all available keyboard keys and **ADVANCED FUNCTION PROGRAMMING (pages 52-67)** where various optional programming features are provided. Find the required functions and program them accordingly.

## 1 Abbreviations and Terminology

- Dept.: Department; a category for merchandise classifications. Every sales item should belong to a department.
- PLU: Price Look Up; a category for merchandise classifications. PLUs are used to call up preset prices by a code entry.
- VAT: Value Added Tax
- X report: Report to read sales data
- Z report: Report to read and reset sales data
- Receipt ON/OFF function: To print or not to print receipts in the REG mode.

## 2 Prior to Programming

### ■ Procedure for programming

1. Check to see whether a paper roll is present in the machine. If there is not enough paper on a roll, replace it with a new one (refer to "Replacing the Paper Roll" in "OPERATOR MAINTENANCE" chapter for the replacement).
2. Put the mode key in the mode switch and turn it to the Z/PGM position.
3. Program necessary items into the cash register.  
Every time you program an item, the cash register will print the setting. Please refer to print samples in each section.
4. If necessary, issue programming reports for your reference.

- NOTE**
- On the key operation example shown in the programming details, numbers such as "221012" indicates the parameter which must be entered using the corresponding numeric keys.
  - Asterisks in the tables shown in the programming details indicate default settings.

### ■ Description of special keys

- ,  to  Used for numerical number entry.
- Used for character code entry.
- Used for cancel entry.
- Used for data decision entry.
- Used for programming termination entry.

## ■ Guidance for text programming

The register allows you to program texts for department item names, PLU/subdepartment item names, logo messages, foreign and domestic currency symbols, and function texts.

There are two ways for programming text; using character keys on the keyboard or entering character codes with numeric keys on the keyboard.

**NOTE** For details of entering character codes with numeric keys, please refer to “PRIOR TO PROGRAMMING” section on pages 43-44.

### Character entry sequence

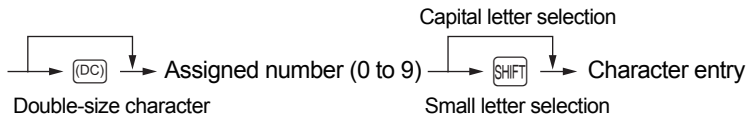

### Assigned number and character table

	<sup>5</sup> 1 A-J	SHIFT <sup>5</sup> 1 A-J	<sup>6</sup> 2 K-T	SHIFT <sup>6</sup> 2 K-T	<sup>7</sup> 3 U-Z	SHIFT <sup>7</sup> 3 U-Z	<sup>8</sup> 4 0-9	SHIFT <sup>8</sup> 4 0-9	CR Ä	SHIFT CR Ä	EX ð	SHIFT EX ð	CH ö	SHIFT CH ö
0	A	a	K	k	U	u	0	0	Ä	ä	Đ	d'	Ò	ò
1	B	b	L	l	V	v	1	1	Ö	ö	È	è	Ó	ó
2	C	c	M	m	W	w	2	2	Ü	ü	É	é	Ô	ô
3	D	d	N	n	X	x	3	3	À	à	Ê	ê	Õ	õ
4	E	e	O	o	Y	y	4	4	Á	á	Ë	ë	Š	š
5	F	f	P	p	Z	z	5	5	Â	â	Ì	ì	Ť	ť
6	G	g	Q	q	%	%	6	6	Ã	ã	Í	í	Ù	ù
7	H	h	R	r	+	+	7	7	Ä	ä	Î	î	Ú	ú
8	I	i	S	s	-	-	8	8	Č	č	Ñ	ñ	Û	û
9	J	j	T	t	!	!	9	9	Ç	ç	Ň	ň	Ž	ž

- SHIFT Used for the small letter entry.
- SPACE Used for a space entry.
- BS Used to delete the last character or figure.
- DC Used for the double-size character entry.
- A-J, K-T, U-Z, 0-9, Ä, ð, ö Used for character entry.

[ Example ] For entry character “MnH”



### 3 Language Selection

#### Procedure

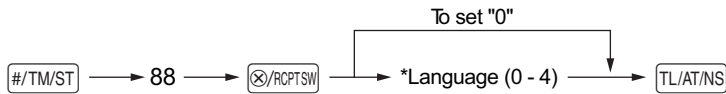

\*Language: 0: English    1: German    2: French    3: Spanish    4: Swedish  
By default, English is set.

#### Key operation example



#### Print



**Caution:** When you change the language, the texts such as logo messages and function texts, which you programmed, will be reset to the default settings. The language selection must be made before programming logo messages and function texts.

### 4 Date and Time Programming

#### Date

For setting the date, enter the date in 6 digits using the day-month-year (DD/MM/YY) format, then press the #/TM/ST key.

#### Procedure

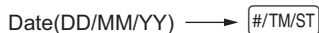

#### Key operation example

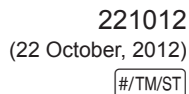

#### Print



#### Time

For setting the time, enter the time in 4 digits using the 24-hour format. For example, when the time is set to 2:30 AM, enter 230; and when it is set to 2:30 PM, enter 1430.

#### Procedure



#### Key operation example



#### Print



## 5 Tax Programming

If you program the VAT/tax, the cash register can calculate the sales tax. In the VAT system, the tax is included in the price you enter in the register, and the tax amount is calculated when tendered according to the VAT rate programmed. In the tax system, the tax is calculated when tendered according to the tax rate programmed, and added to the price. The cash register can provide totally 6 kinds of VAT/tax systems (automatic VAT1-4, automatic tax 1-4, manual VAT 1-4, manual VAT 1, manual tax 1-4, and automatic VAT1 and automatic tax 2-4 systems) and 4 kinds of rates. By default, the cash register is pre-programmed as automatic VAT1-4 system.

When you program tax rate(s) and taxable status for each department (by default, VAT1/tax1 is set to taxable.), tax will be automatically added to sales of items assigned to the department according to the programmed tax status for the department and the corresponding tax rate(s).

For details of the tax systems, refer to "Computation of VAT (Value Added Tax)/tax" section. To change the tax system, please refer to "Other programming" of "Various Function Selection Programming 1" section (Job code 69).

### ■ Tax rate programming

The percent rate specified here is used for tax calculation on taxable subtotals.

#### Procedure

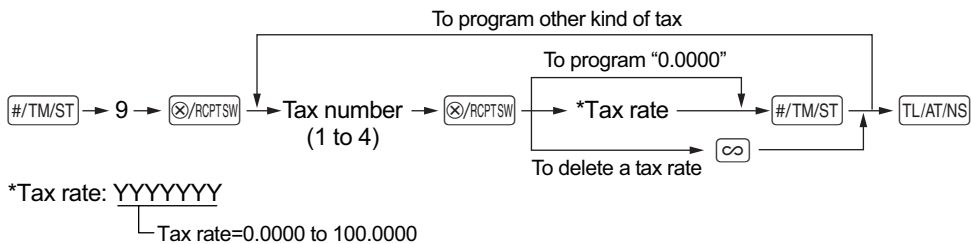

#### Key operation example

```

#/TM/ST 9 ⊗/RCPTSW
          2 ⊗/RCPTSW
0070000
          #/TM/ST
          TL/AT/NS
    
```

#### Print

```

          *PGM*
TAX2      7. 0000%
           0. 00
    
```



## 6 Department Programming

Merchandise can be classified into a maximum of 8 departments. Items sold using the department keys can later be printed on a report shown as the quantities sold and sales amounts classified by department. The data is useful for making purchasing decisions and other store operations.

### Department status

#### Procedure

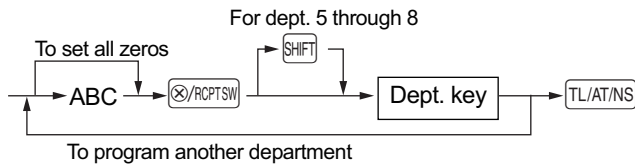

Item:	Selection:	Entry:
A	SICS / Normal	SICS
		Normal*
B	Sign	Negative department
		Positive department*
C	Type of unit price entry	Open and preset
		Preset only
		Open only*
		Inhibit department key

\* Default settings

### SICS (Single Item Cash Sale)

- If an entry of a department programmed for SICS is made first, the sale will be finalized as a cash sale as soon as the department key is pressed. If the entry is made after entering a department not programmed for SICS, it does not finalize and result in a normal sale.

#### Key operation example

113

#### Print

```

    *PGM*
    D02
    DEPT. 02
    T1
    -0.00
    183
  
```

Type of unit price entry  
 SICS / Normal  
 Sign

## ■ Preset unit price

### Procedure

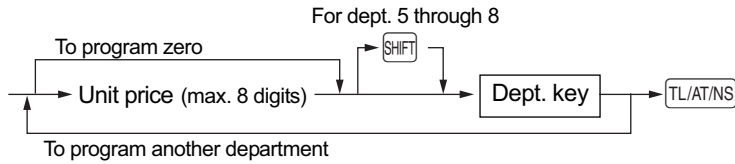

### Key operation example

1000  <sup>5</sup>

### Print

```

*PGM*
D01      10.00  Unit price
DEPT.01  T1    083
  
```

**NOTE** If a department is not programmed to allow the entry of preset unit prices in functional programming, the department is automatically changed to allow the entry of preset unit prices by this programming entry.

## ■ VAT/tax status

### Procedure

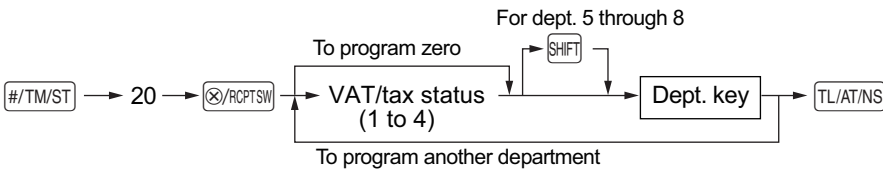

VAT/tax status	Selection:	Entry:
VAT/tax 1*	1	e.g. for this number a VAT/tax rate of 7% is assigned
VAT/tax 2	2	
VAT/tax 3	3	
VAT/tax 4	4	
Non VAT/tax	0	

### Key operation example

#/TM/ST 20  RCPTSW  
  <sup>5</sup>

### Print

```

*PGM*
D01      10.00
DEPT.01  T 2  083
  
```

VAT/tax status (VAT/tax 2)

## ■ HALO digits (entry digit limit)

Set the number of allowable digits for the maximum entry amount for each department. The limit is effective for operations in the REG mode.

**NOTE** To activate this function, the programming (job code 62) "HALO function" must be set "Valid (1)" on page 55.

### Procedure

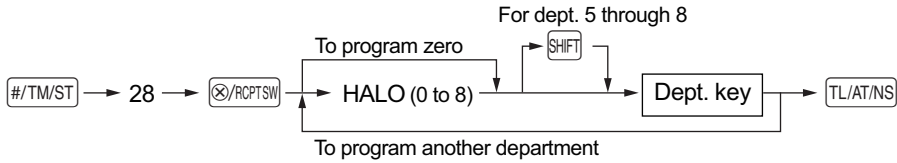

#### Key operation example

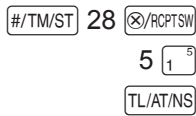

#### Print

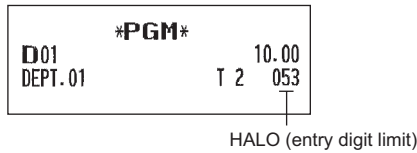

## ■ Department text (item label)

### Procedure

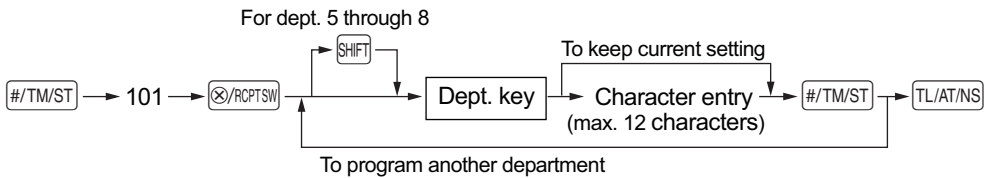

#### Key operation example

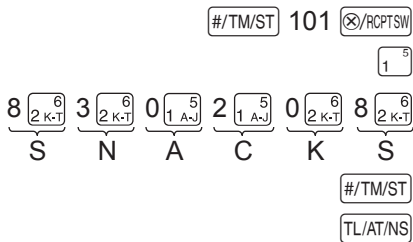

(Programming SNACKS for dept.1)

#### Print

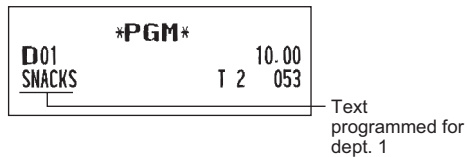

For details of the text entry ("SNACKS"), please refer to the "Guidance for text programming" on page 12.

## 7 PLU (Price Look-Up) and Subdepartment Programming

The PLU function allows speedy key entries whereby a price is automatically called up when a code is entered. The subdepartment is a kind of "open PLU", which requires you to enter a price after the PLU code is entered. PLU/subdepartment setting for 1 through 200 codes are available.

### Unit price and associated department assignment

#### Procedure

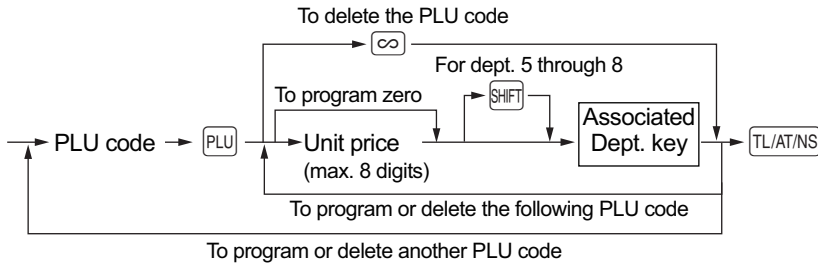

#### Key operation example

1   
 125

#### Print

*PGM*	
P001 (01)	1
PLU.001	1.25

PLU code Unit price Associated dept.

### PLU/subdepartment selection

#### Procedure

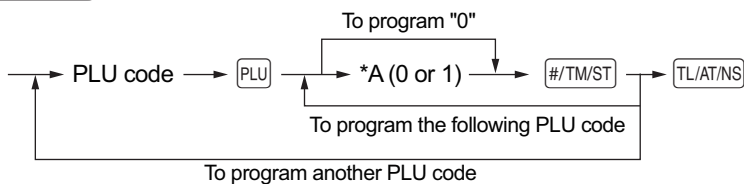

\*A: 0 for subdepartment or 1 for PLU

#### Key operation example

1   
 0

#### Print

*PGM*	
P001 (01)	0
PLU.001	1.25

PLU/subdept.

**NOTE** When you program the last PLU code, the programming sequence will be complete with a press of the  key.

## ■ PLU text (item label)

### Procedure

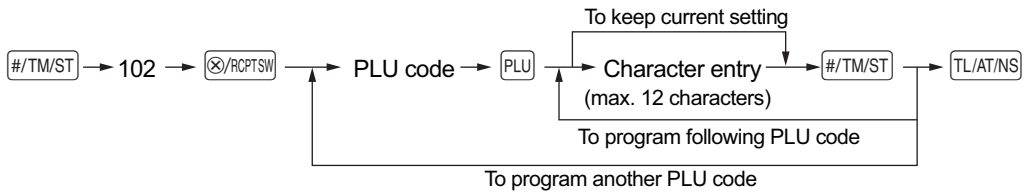

### Key operation example

```

#/TM/ST 102 ⊗/RCPTSW
          1 PLU
MELON   #/TM/ST
        TL/AT/NS
    
```

(Programming MELON to PLU1)

### Print

```

*PGM*
P001 (01) 0
MELON      1.25
    
```

Text programmed for PLU code 1

For details of the text entry ("MELON"), please refer to the "Guidance for text programming" on page 12.

(M:2  $\begin{matrix} 6 \\ 2 \text{ K-T} \end{matrix}$ , E:4  $\begin{matrix} 5 \\ 1 \text{ A-J} \end{matrix}$ , L:1  $\begin{matrix} 6 \\ 2 \text{ K-T} \end{matrix}$ , O:4  $\begin{matrix} 6 \\ 2 \text{ K-T} \end{matrix}$ , N:3  $\begin{matrix} 6 \\ 2 \text{ K-T} \end{matrix}$ )

## 8 Text Programming

Please refer to “Guidance for text programming” section as for how to entering characters.

### ■ Logo messages (6 lines and 30 characters for each line)

The register can print programmed messages on every receipt. On the standard model, a header 3-line and footer 3-line logo message is printed on the receipt. If you want to print in other logo message format, please change the format. For the programming details, refer to “Logo message print format” on page 61.

#### Procedure

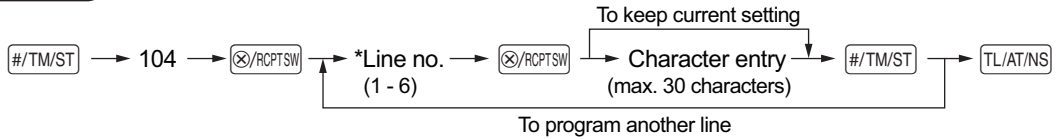

\*Line no.: “Header 3-line message” type : 1 to 3

“Header 6-line message” type : 1 to 6

“Header 3-line and footer 3-line message” type: 1 to 6 (1 to 3 as header, 4 to 6 as footer)

#### Logo message print format (3 types)

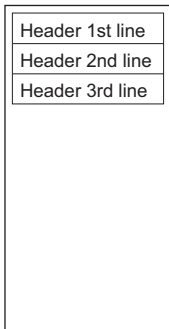

Header 3-line message

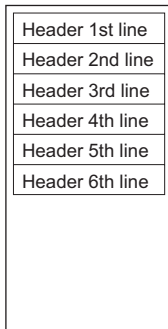

Header 6-line message

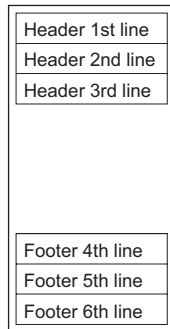

Header 3-line message and footer 3-line message (Default setting)

#### NOTE

A header 3-line and footer 3-line logo message is preprogrammed when shipped. Please start entering from the first line when you first program a logo message.

To print the logo message “THANK YOU” using double sized characters and centering on the third line.

**Key operation example**

```

# / TM / ST 104 [⊗] / RCPT SW
3 [⊗] / RCPT SW
(DC) (SPACE) (DC) (SPACE) (DC) (SPACE)
(DC) T (DC) H (DC) A (DC) N (DC) K
(DC) (SPACE) (DC) Y (DC) O (DC) U
# / TM / ST
TL / AT / NS
    
```

**Print**

```

*PGM*
THANK YOU
    
```

For details of the text entry, please refer to the “Guidance for text programming” on page 12.

(T:9 [2 K-T], H:7 [1 A-J], A:0 [1 A-J], N:3 [2 K-T], K:0 [2 K-T], Y:4 [3 U-Z], O:4 [2 K-T], U:0 [3 U-Z])

# BASIC SALES ENTRY (Example)

## 1 Basic Sales Entry

Listed below is a basic sales entry example when selling items by cash. For operation details, please refer to "Additional Information for BASIC SALES ENTRY" on page 29.

### Mode switch setting

1. Turn the mode switch to the REG position.

### Item entries

2. Enter the price for the appropriate department. For example if the price 15.00 EURO, enter "1500" by numeric keys and then press the appropriate department key.  
For department 5 to department 8, press the **[SHIFT]** key first before pressing the department key.
3. Repeat step 2 for all department items.

### Displaying subtotals

4. Press the **[#/TM/ST]** key to display the amount due.

### Finalizing the transaction

5. Enter the amount received from the customer. (You can omit this step if the amount tendered is the same as the subtotal.)
6. Press the **[TL/AT/NS]** key, and the change due is displayed and the drawer is opened.
7. Tear off the receipt and give it to the customer with his or her change.
8. Close the drawer.

### Key operation example

### Operator display

Item entries	{ 1500 <b>[1]</b> <sup>5</sup> { 2300 <b>[2]</b> <sup>9</sup>	<b>[01]</b> 15.00
		<b>[02]</b> 23.00
Displaying subtotal	→ <b>[#/TM/ST]</b>	<b>[0]</b> 38.00
Amount tendered	→ 4000	<b>[4000]</b>
Finalizing the transaction	→ <b>[TL/AT/NS]</b>	<b>[C]</b> 2.00

(In this example, tax system is set to automatic VAT 1-4 and the tax1 rate is set to 7%.)

### Receipt print

<b>THANK YOU FOR YOUR PURCHASE</b>		Logo message (Header)
22/10/12 19:27	000000#000036	Date/Time Register number/ Consecutive number
1x 15.00	*15.00	Price
DEPT. 01		Items
1x 23.00	*23.00	
DEPT. 02		
SUBTOTAL	*38.00	
-----		
TAX1 ST	*38.00	
VAT 1	*2.49	
NET 1	*35.51	
-----		
ITEMS 2Q		Total quantity
***TOTAL	<b>*38.00</b>	Total amount
CASH	*40.00	Cash tendering/amount received
CHANGE	*2.00	Change
<b>WE ARE LOOKING FORWARD TO YOUR NEXT VISIT</b>		Logo message (Footer)



## 2 PLU Sales Entry

Enter a PLU code using numeric keys and press the **PLU** key.

Key operation example	Operator display	Receipt print
1 <b>PLU</b>	001 1.50	1x 1.50 *1.50
71 <b>PLU</b>	071 15.00	PLU.001 *15.00
141 <b>PLU</b> 3620 <b>PLU</b>	141 36.20	1x 15.00 *15.00
<b>TL/AT/NS</b>	F 52.70	PLU.071 *36.20
		1x 36.20 *36.20
		PLU.141
		ITEMS 3Q
		CASH *52.70

# CORRECTION

## 1 Cancellation of the Numeric Entry

If you make an incorrect numeric entry, you can clear the entry by pressing the **CL** key only before pressing a department key, PLU/subdepartment key or the **%** key.

## 2 Correction of the Last Entry (direct void)

If you make an incorrect entry relating to a department, PLU/subdepartment or percentage (**%**), you can void this entry by pressing the **∞** key immediately after the incorrect entry.

Key operation example	Operator display	Receipt print
1250 <b>SHIFT</b> <b>2</b> <sup>9</sup>	06 1250	1x 12.50 *12.50
<b>∞</b>	06 - 1250	DEPT. 06 V-12.50
2 <b>PLU</b>	002 150	1x 1.50 *1.50
<b>∞</b>	002 - 150	PLU. 002 V-1.50
600 <b>SHIFT</b> <b>4</b> <sup>8</sup>	08 600	1x 6.00 *6.00
<b>%</b>	-0.90	DEPT. 08 -15.00% -0.90
<b>∞</b>	0.90	% -15.00% V*0.90
1 <b>PLU</b>	001 328	1x 3.28 *3.28
<b>TL/AT/NS</b>	F 928	PLU. 001
		ITEMS 20
		CASH *9.28

### 3 Correction of the Next-to-last or Earlier Entry (indirect void)

You can void any incorrect department entry, PLU/subdepartment entry or item refund entry made during a transaction if you find it before finalizing the transaction (e.g. pressing the **TL/AT/NS** key). This function is applicable to department, PLU/subdepartment and refund entries only.

Press the **∞** key just before you press a department key or **PLU** key.

Key operation example	Operator display	Receipt print
1310 <b>SHIFT</b> <b>2</b> <sup>9</sup>	06 13.10	1x 13.10 *13.10
1755 <b>SHIFT</b> <b>3</b> <sup>7</sup>	07 17.55	1x 17.55 *17.55
10 <b>PLU</b>	010 7.15	DEPT. 07 1x 7.15 *7.15
12 <b>PLU</b>	012 3.60	PLU. 010 1x 3.60 *3.60
825 <b>SHIFT</b> <b>3</b> <sup>7</sup>	07 8.25	PLU. 012 1x 8.25 *8.25
Correction of a department entry → 1310 <b>∞</b> <b>SHIFT</b> <b>2</b> <sup>9</sup>	06 - 13.10	DEPT. 07 -1x 13.10 V-13.10
Correction of a PLU entry → 12 <b>∞</b> <b>PLU</b>	012 - 3.60	DEPT. 06 -1x 3.60 V-3.60
<b>TL/AT/NS</b>	F 32.95	PLU. 012
		ITEMS 3Q *32.95
		CASH

### 4 Subtotal Void

You can void an entire transaction. Once subtotal void is executed, the transaction is aborted and the register issues a receipt.

Key operation example	Operator display	Receipt print
1310 <b>2</b> <sup>9</sup>	02 13.10	1x 13.10 *13.10
<b>2</b> <sup>9</sup>	2 13.10	DEPT. 02 1x 13.10 *13.10
1755 <b>SHIFT</b> <b>2</b> <sup>9</sup>	06 17.55	DEPT. 02 1x 17.55 *17.55
10 <b>PLU</b>	010 7.15	DEPT. 06 1x 7.15 *7.15
35 <b>PLU</b>	035 10.00	PLU. 010 1x 10.00 *10.00
Subtotal void {	<b>#/TM/ST</b>	PLU. 035 SUBTOTAL *60.90
	<b>∞</b>	SBTL VOID -60.90
	<b>#/TM/ST</b>	***TOTAL. *0.00

## 5 Correction after Finalizing a Transaction (Void mode)

When you need to void incorrect entries that are found after finalizing a transaction or cannot be corrected by direct, indirect void or subtotal void, the following steps should be taken:

1. Turn the mode switch to the  position using the mode key, to enter into the void mode.
2. Repeat the entries that are recorded on an incorrect receipt. (All data on the incorrect receipt is removed from register memory; the voided amounts are added to the void mode transaction totalizer.)

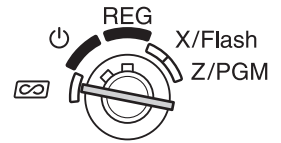

Incorrect receipt	
1x 10.00	*10.00
DEPT. 04	
1x 1.50	*1.50
DEPT. 03	
ITEMS 2Q	
CASH	<b>*11.50</b>

➔

Cancellation receipt	
* VOID MODE *	
1x 10.00	*10.00
DEPT. 04	
1x 1.50	*1.50
DEPT. 03	
ITEMS 2Q	
CASH	<b>*11.50</b>

# FULL SALES REPORT (X or Z REPORT)

- Use the reading function (X) when you need to take a reading of sales information entered since the last reset. You can take this reading any number of times. It does not affect the register's memory.
- Use the resetting function (Z) when you need to clear the register's memory. Resetting prints all sales information and clears the entire memory except for the GT1 through GT3, reset count, and consecutive number.

X1 and Z1 reports: Daily sales reports

X2 and Z2 reports: Periodic (monthly) consolidation reports

When you take an X1 or X2 report, turn the mode switch to the X/Flash position, and use the corresponding key sequence.

When you take an Z1 or Z2 report, turn the mode switch to the Z/PGM position, and use the corresponding key sequence.

## ■ Daily full sales report (X1 or Z1 report)

Put the mode key in the mode switch and turn it to the X/Flash or the Z/PGM position.

### Key operation

TL/AT/NS (For Z1 report: in the Z/PGM position)

### Sample report

*Z1*	Mode title*1	
*2	Z1 0001	Reset counter
GT1	*00000000345.08	Net grand total (GT2-GT3)
GT2	*00000000399.04	Grand total of plus registration
GT3	-00000000053.96	Grand total of minus registration
-----		
DEPT.		
D01	42 Q	Dept. code
DEPT. 01	*182.42	Sales q'ty
D02	15 Q	Sales amount
DEPT. 02	*50.00	
D03	10 Q	
DEPT. 03	*19.34	
D04	7 Q	
DEPT. 04	*21.83	
D05	4 Q	
-----		
DEPT. 06	*20.88	
D08	11 Q	
DEPT. 08	*68.53	
*DEPT TL	93 Q	"+" dept. counter
	*369.08	and total
-----		
D07	7 Q	
DEPT. 07	-21.77	
DEPT (-)	7 Q	"-" dept. counter
	-21.77	and total
-----		
TRANSACTION		
%	2 Q	Subtotal percent
	-2.23	counter and total
NET 1	*345.08	Net sales total

TAX1 ST	*254.70	Taxable 1 total
VAT 1	*35.13	VAT 1 total
TAX2 ST	*50.00	
VAT 2	*3.27	
TAX3 ST	*18.55	
VAT 3	*1.37	
TAX4 ST	*21.83	
VAT 4	*2.16	
TTL TAX	*41.93	Tax total
NET	*303.15	Net total without tax
-----		
%	3 Q	Item percent
	-0.45	counter and total
VOID	4 Q	Item void counter
	*19.01	and total
VOID MODE	1 Q	Void-mode transaction
	*10.50	counter and total
SBTL VOID	1 Q	Subtotal void counter
	*8.95	and total
-----		
NO SALE	2 Q	No-sales counter
GUEST	11 Q	Customer counter
-----		
PAID TL	*345.08	Paid total
AVE.	*31.37	Paid total average per customer
SCM (+)	*200.00	Starting cash memory (+)
SCM (-)	-100.00	Starting cash memory (-)
SCM TTL	*100.00	Starting cash memory total
***RA	1 Q	Received on account
	*100.00	counter and total
***PO	1 Q	Paid out counter and total
	*50.00	

(To be continued on the next page)

\*1: When you take X1 report, "X1" is printed.

\*2: Printed in the Z1 report only.

CASH	5 Q	} Cash counter and total
	*263.44	
CHECK	2 Q	} Cheque sales counter and total
	*47.00	
CREDIT	2 Q	} Credit sale and tendering counter and total
	*15.40	
EXCH	2 Q	} Exchange counter and total
	22.00	
DOM. CUR	*23.39	Domestic currency
-----		
***CID	*409.29	Cash in drawer
*CH ID	*47.00	Cheque in drawer
CA/CHK ID	*456.29	Cash + cheque in drawer
CHK/CG	*3.40	Change total for cheque tendering

## ■ Periodic consolidation (X2 or Z2 report)

Put the mode key in the mode switch and turn it to the X/Flash or the Z/PGM position.

### Key operation

**SHIFT** **TL/AT/NS** (For Z2 report: in the Z/PGM position)

### Sample report

*Z2*		Mode title*1
	Z1 0004	Reset counter of daily total
	Z2 0001	Reset counter of periodic consolidation
GT1	*00000000804.22	} Grand total
GT2	*00000000859.84	
GT3	-0000000055.62	

↓

The subsequent printouts are the same in format as in the Z1 full sales report.

\*1: When you take X2 report, "X2" is printed.

\*2: Printed in the Z2 report only

# OTHER BASIC SALES ENTRIES

## 1 Additional Information for BASIC SALES ENTRY

### Receipt ON/OFF function

When you use the printer to issue receipts, you can disable receipt printing in the REG mode to save paper using the receipt ON/OFF function. To disable receipt printing, press the  $\text{RCPTSW}$  key.

This key toggles the receipt printing status ON and OFF.

The register will print reports regardless of the receipt state, so the paper roll must be installed.

### To issue a receipt when receipt ON/OFF function is set to OFF:

If your customer wants a receipt after you finalized a transaction with the receipt ON/OFF function being OFF status, press the  $\text{RCPTRA}$  key. This will produce a receipt. However, if more than 40 items were entered, the receipt will be issued in a summary receipt.

### Copy receipt

You can print a copy receipt by pressing the  $\text{RCPTRA}$  key.

To realize this function, you must enable the function. Please refer to page 55 (Job code 63).

### Power Save Mode

The register will enter into power save mode when no entries are performed based on the pre-programmed time limit (by default, 30 minutes).

When the register goes to the power save mode, all display lights will turn off except the decimal point at the leftmost position. The register will return to the normal operation mode when any key is pressed or a mode is changed with the mode key. Please note when the register is recovered by a key entry, its key entry is invalid. After the recovery, start the key entry from the beginning.

## 2 Error Warning

In the following examples, your register will go into an error state with an error symbol “E” on the display. Clear the error state by pressing the  $\text{CL}$  key and take the proper action.

Please refer to the error code table on page 81.

- Enter over a 32-digit number (entry limit overflow): Cancel the entry and re-enter the correct number.
- An error in key operation: Clear the error and continue operation.
- A merchandise subtotal exceeds eight digits: Delete the subtotal by pressing the  $\text{CL}$  key and press the  $\text{TL/AT/NS}$ ,  $\text{CH}$  or  $\text{CR}$  key to finalize the transaction.

### Error escape function

To quit a transaction due to an error or an unforeseen event, use the error escape function as shown below:

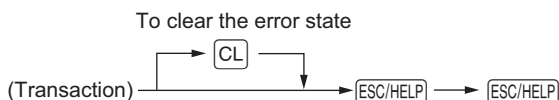

The transaction is voided (treated as a subtotal void) and the receipt is issued by this function. If you have already entered a tendered amount, the operation is finalized as a cash sale.

### 3 Starting Cash Memory (SCM) Entry

If you enter the amount of currency for the starting amount in the drawer before entry operations, you can separate that amount from the sales amount when reports are generated.

Your register can be programmed to enforce the entry of starting cash into memory.

#### Procedure

1. Turn the mode switch to the X/Flash position.
2. Enter the amount for domestic currency by using the numeric keys.
3. Press the **RCPT/RA** key for SCM(+) function, or press the **PO/VAT** key for SCM(-) function.

Key operation	Print						
250 <b>RCPT/RA</b>	<table border="1"><tr><td colspan="2" style="text-align: center;"><b>*X1*</b></td></tr><tr><td>SCM(+)</td><td>*0.00</td></tr><tr><td>SCM TTL</td><td>*2.50</td></tr></table>	<b>*X1*</b>		SCM(+)	*0.00	SCM TTL	*2.50
<b>*X1*</b>							
SCM(+)	*0.00						
SCM TTL	*2.50						

Key operation	Print								
250 <b>PO/VAT</b>	<table border="1"><tr><td colspan="2" style="text-align: center;"><b>*X1*</b></td></tr><tr><td>SCM(-)</td><td>*2.50</td></tr><tr><td>SCM TTL</td><td>-2.50</td></tr><tr><td></td><td>*0.00</td></tr></table>	<b>*X1*</b>		SCM(-)	*2.50	SCM TTL	-2.50		*0.00
<b>*X1*</b>									
SCM(-)	*2.50								
SCM TTL	-2.50								
	*0.00								



## 4 Item Entries

### Single item entries

#### Department entries

Enter a unit price and press a department key. If you use a programmed unit price, press a department key only.

#### Procedure

When using a programmed unit price

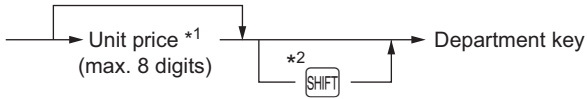

#### NOTE

\*1 Less than the programmed upper limit amounts

When those departments for which the unit price has been programmed as zero (0) are entered, only the sales quantity is added.

\*2 For the departments 5 through 8, press the **SHIFT** key.

#### Example

Key operation	Print
1200 <b>1</b> <sup>5</sup>	1x 12.00           *12.00
<b>3</b> <sup>7</sup>	DEPT. 01
2600 <b>SHIFT</b> <b>2</b> <sup>6</sup>	1x 7.10           *7.10
<b>TL/AT/NS</b>	DEPT. 03
	1x 26.00           *26.00
	DEPT. 06
	ITEMS 3Q
	<b>CASH           *45.10</b>

## PLU/subdepartment entries

Enter a PLU code and press the **PLU** key. If you do not use a programmed unit price, you need to enter a unit price after pressing the **PLU** key (subdepartment).

By default, these 200 codes are set to PLU mode and zero for unit price.

### • PLU entries

PLU code → **PLU**

When zero price PLU is entered, only the sales quantity is added.

### • Subdepartment (open PLU) entries

PLU code → **PLU** → Unit price \* → **PLU**  
(max. 8 digits)

\* Less than the programmed upper limit amounts.

### Example

Key operation	Print
2 <b>PLU</b>	1x 5.10 *5.10
16 <b>PLU</b>	PLU.002
1200	1x 12.00 *12.00
<b>PLU</b>	PLU.016
<b>TL/AT/NS</b>	ITEMS 2Q
	<b>CASH *17.10</b>

## Repeat entries

The Repeat Entry function allows you to enter a sale of two or more of the same items.

You can simply press the department key or **PLU** key to repeat entry.

### Example

Key operation	Print
Repeated department entry { 200 <b>2</b> <sup>6</sup>	1x 2.00 *2.00
	DEPT.02
	1x 2.00 *2.00
Repeated department entry { 680 <b>SHIFT 3</b> <sup>7</sup>	DEPT.02
	1x 2.00 *2.00
	1x 6.80 *6.80
Repeated PLU entry { 10 <b>PLU</b>	DEPT.07
	1x 6.80 *6.80
	1x 5.10 *5.10
Repeated subdepartment entry { 60 <b>PLU</b> 500 <b>PLU</b>	PLU.010
	1x 5.10 *5.10
	PLU.010
	1x 5.10 *5.10
	PLU.010
	1x 5.00 *5.00
	PLU.060
1x 5.00 *5.00	
<b>TL/AT/NS</b>	ITEMS 10Q
	<b>CASH *44.90</b>

## ■ Multiplication entries

Use this feature when you need to enter two or more of the same items.  
This feature helps you when you sell a large quantity of items.

### Procedure

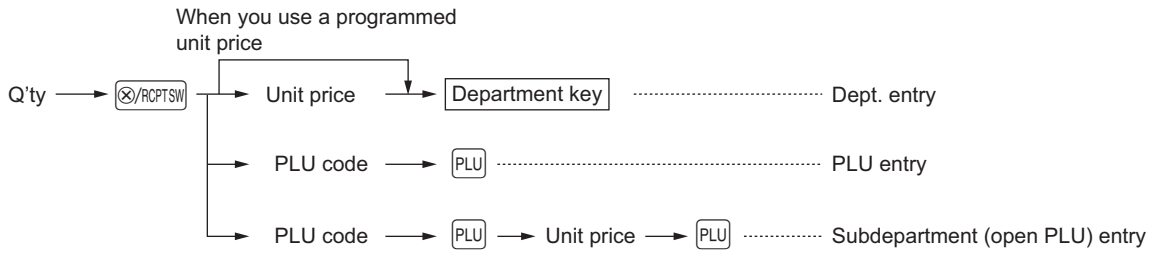

- Q'ty: Up to four-digit integer
- Unit price: Less than a programmed upper limit
- Q'ty x unit price: Up to eight digits

### Example

Key operation	Print
7 ⊗/RCPTSW	7x 1.65 *11.55
165 2 <sup>o</sup>	DEPT. 02
2 ⊗/RCPTSW	2x 2.50 *5.00
250 SHIFT 2 <sup>o</sup>	DEPT. 06
15 ⊗/RCPTSW	15x 6.50 *97.50
6 PLU	PLU. 006
8 ⊗/RCPTSW	8x 1.00 *8.00
17 PLU	PLU. 017
100 PLU	ITEMS 32Q
TL/AT/NS	CASH *122.05

## ■ Single item cash sale (SICS)

- This function is useful when a sale is for only one item and is for cash; such as a pack of cigarettes. This function is applicable only to those departments that have been set for SICS or to their associated PLUs.
- The transaction is finalized and the drawer opens as soon as you press the department key or **PLU** key.

### Example

Key operation	Print								
For finishing the transaction → 250 → <b>3</b>	<table border="1"><tr><td>1x 2.50</td><td>*2.50</td></tr><tr><td>DEPT.03</td><td></td></tr><tr><td>ITEMS 1Q</td><td></td></tr><tr><td>CASH</td><td>*2.50</td></tr></table>	1x 2.50	*2.50	DEPT.03		ITEMS 1Q		CASH	*2.50
1x 2.50	*2.50								
DEPT.03									
ITEMS 1Q									
CASH	*2.50								

**NOTE** If an entry to a department, PLU/subdepartment set for SICS follows the ones to departments, PLUs/subdepartments not set for SICS, it does not finalize and results in a normal sale.

## 5 Display of Subtotal

### ■ Subtotal

Press the **#/TM/ST** key at any point during a transaction. The sales subtotal including tax will appear with the symbol “**σ**” in the display.

**NOTE** Subtotal will not be printed on a receipt on the current factory setting. If you want to print it, change the setting by programming. Refer to “Receipt print format” (Job code 7) on page 54.

## 6 Finalization of Transaction

### ■ Cash or cheque tendering

Press the **[#/TM/ST]** key to get a subtotal, enter the amount tendered by your customer, then press the **[TL/AT/NS]** key if it is a cash tender or press the **[CH]** key if it is a cheque tender. When the amount tendered is greater than the amount of the sale, the register will show the change due amount with the symbol “**⌈**”. Otherwise the register will show a deficit with the symbol “**⌋**”. Make a correct tender entry.

#### Example

#### Cash tendering

Key operation	Print																
? #/TM/ST 1000 TL/AT/NS	<table border="1"> <tr> <td>1x 1.20</td> <td>*1.20</td> </tr> <tr> <td>DEPT. 01</td> <td></td> </tr> <tr> <td>1x 2.50</td> <td>*2.50</td> </tr> <tr> <td>DEPT. 02</td> <td></td> </tr> <tr> <td>ITEMS 2Q</td> <td></td> </tr> <tr> <td>***TOTAL</td> <td><b>*3.70</b></td> </tr> <tr> <td>CASH</td> <td>*10.00</td> </tr> <tr> <td>CHANGE</td> <td>*6.30</td> </tr> </table>	1x 1.20	*1.20	DEPT. 01		1x 2.50	*2.50	DEPT. 02		ITEMS 2Q		***TOTAL	<b>*3.70</b>	CASH	*10.00	CHANGE	*6.30
1x 1.20	*1.20																
DEPT. 01																	
1x 2.50	*2.50																
DEPT. 02																	
ITEMS 2Q																	
***TOTAL	<b>*3.70</b>																
CASH	*10.00																
CHANGE	*6.30																

#### Cheque tendering

Key operation	Print																
? #/TM/ST 1000 CH	<table border="1"> <tr> <td>1x 1.20</td> <td>*1.20</td> </tr> <tr> <td>DEPT. 01</td> <td></td> </tr> <tr> <td>1x 2.50</td> <td>*2.50</td> </tr> <tr> <td>DEPT. 02</td> <td></td> </tr> <tr> <td>ITEMS 2Q</td> <td></td> </tr> <tr> <td>***TOTAL</td> <td><b>*3.70</b></td> </tr> <tr> <td>CHECK</td> <td>*10.00</td> </tr> <tr> <td>CHANGE</td> <td>*6.30</td> </tr> </table>	1x 1.20	*1.20	DEPT. 01		1x 2.50	*2.50	DEPT. 02		ITEMS 2Q		***TOTAL	<b>*3.70</b>	CHECK	*10.00	CHANGE	*6.30
1x 1.20	*1.20																
DEPT. 01																	
1x 2.50	*2.50																
DEPT. 02																	
ITEMS 2Q																	
***TOTAL	<b>*3.70</b>																
CHECK	*10.00																
CHANGE	*6.30																

### ■ Mixed tendering (cheque + cash)

#### Example

Key operation	Print																		
? #/TM/ST 1000 CH 500 TL/AT/NS	<table border="1"> <tr> <td>1x 5.10</td> <td>*5.10</td> </tr> <tr> <td>PLU. 010</td> <td></td> </tr> <tr> <td>2x 4.80</td> <td>*9.60</td> </tr> <tr> <td>PLU. 008</td> <td></td> </tr> <tr> <td>ITEMS 3Q</td> <td></td> </tr> <tr> <td>***TOTAL</td> <td><b>*14.70</b></td> </tr> <tr> <td>CHECK</td> <td>*10.00</td> </tr> <tr> <td>CASH</td> <td>*5.00</td> </tr> <tr> <td>CHANGE</td> <td>*0.30</td> </tr> </table>	1x 5.10	*5.10	PLU. 010		2x 4.80	*9.60	PLU. 008		ITEMS 3Q		***TOTAL	<b>*14.70</b>	CHECK	*10.00	CASH	*5.00	CHANGE	*0.30
1x 5.10	*5.10																		
PLU. 010																			
2x 4.80	*9.60																		
PLU. 008																			
ITEMS 3Q																			
***TOTAL	<b>*14.70</b>																		
CHECK	*10.00																		
CASH	*5.00																		
CHANGE	*0.30																		

#### NOTE

When programmed not to allow “direct non-tender finalization after tendering” (Job code 63) on page 55, you must enter a tender amount.

## ■ Cash or cheque sale that does not need any tender entry

Enter items and press the **[TL/AT/NS]** key if it is a cash sale or press the **[CH]** key if it is a cheque sale. The register will display the total sales amount.

### Example

Key operation	Print
300 <b>[3]</b> <sup>7</sup>	1x 3.00 *3.00
10 <b>[PLU]</b>	DEPT. 03
<b>[TL/AT/NS]</b>	1x 5.10 *5.10
	PLU. 010
	ITEMS 2Q
	<b>CASH *8.10</b>
	In the case of cheque sale
	1x 3.00 *3.00
	DEPT. 03
	1x 5.10 *5.10
	PLU. 010
	ITEMS 2Q
	<b>CHECK *8.10</b>

**NOTE** When the function parameters is programmed to “amount tendered entry; compulsory(1)” on page 48, the direct non-tender finalization is inhibited.

## ■ Credit sale

Enter items and press the **[CR]** key.

### Example

Key operation	Print
<b>[4]</b> <sup>8</sup>	1x 4.50 *4.50
<b>[4]</b> <sup>8</sup>	DEPT. 04
<b>[#/TM/ST]</b>	1x 4.50 *4.50
<b>[CR]</b>	DEPT. 04
	ITEMS 2Q
	<b>CREDIT *9.00</b>

## ■ Mixed-tender sale

### Example

Key operation	Print																						
$\} \rightarrow$ $\rightarrow$ <span style="border: 1px solid black; padding: 2px;">#/TM/ST</span> 950 <span style="border: 1px solid black; padding: 2px;">TL/AT/NS</span> <span style="border: 1px solid black; padding: 2px;">CR</span>	<table border="1"> <tr><td>1x 1.20</td><td>*1.20</td></tr> <tr><td>DEPT. 01</td><td></td></tr> <tr><td>1x 2.50</td><td>*2.50</td></tr> <tr><td>DEPT. 02</td><td></td></tr> <tr><td>3x 3.00</td><td>*9.00</td></tr> <tr><td>DEPT. 03</td><td></td></tr> <tr><td colspan="2"> </td></tr> <tr><td>ITEMS 5Q</td><td></td></tr> <tr><td>***TOTAL</td><td><b>*12.70</b></td></tr> <tr><td>CASH</td><td>*9.50</td></tr> <tr><td>CREDIT</td><td>*3.20</td></tr> </table>	1x 1.20	*1.20	DEPT. 01		1x 2.50	*2.50	DEPT. 02		3x 3.00	*9.00	DEPT. 03				ITEMS 5Q		***TOTAL	<b>*12.70</b>	CASH	*9.50	CREDIT	*3.20
1x 1.20	*1.20																						
DEPT. 01																							
1x 2.50	*2.50																						
DEPT. 02																							
3x 3.00	*9.00																						
DEPT. 03																							
ITEMS 5Q																							
***TOTAL	<b>*12.70</b>																						
CASH	*9.50																						
CREDIT	*3.20																						

**NOTE** Press the CH key in place of the TL/AT/NS key when your customer makes payment by cheques.

## 7 Computation of VAT (Value Added Tax)/Tax

### ■ VAT/tax system

The cash register may be programmed for the following six VAT/tax systems. The cash register is preprogrammed as automatic VAT 1-4 system.

#### Automatic VAT 1 through 4 system (Automatic operation method using programmed percentages)

This system, at settlement, calculates VAT for taxable 1, taxable 2, taxable 3, and taxable 4 subtotals by using the corresponding programmed percentages.

#### Automatic tax 1 through 4 system (Automatic operation method using programmed percentages)

This system, at settlement, calculates taxes for taxable 1, taxable 2, taxable 3, and taxable 4 subtotals by using the corresponding programmed percentages, and also adds the calculated taxes to those subtotals, respectively.

#### Manual VAT 1 through 4 system (Manual entry method using programmed percentages)

##### Procedure



This system provides the VAT calculation for taxable 1, taxable 2, taxable 3, and taxable 4 subtotals. This calculation is performed using the corresponding programmed percentages when the PO/VAT key is pressed just after the #/TM/ST key.

#### Manual VAT 1 system (Manual entry method for subtotals that uses VAT 1 preset percentages)

##### Procedure

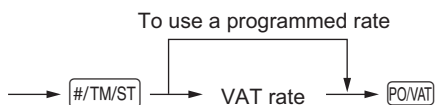

This system enables the VAT calculation for the subtotal. This calculation is performed using the VAT 1 preset percentages when the PO/VAT key is pressed just after the #/TM/ST key. For this system, the keyed-in tax rate can be used.

## Manual tax 1 through 4 system (Manual entry method using programmed percentages)

### Procedure



This system provides the tax calculation for taxable 1, taxable 2, taxable 3, and taxable 4 subtotals. This calculation is performed using the corresponding programmed percentages when the  key is pressed just after the  key. After this calculation, you must finalize the transaction.

### Automatic VAT 1 and tax 2 through 4

This system enables the calculation in the combination with automatic VAT 1 and tax 2 through 4. This combination can be any of VAT 1 and tax 2 through 4. The tax amount is calculated automatically with the percentages previously programmed for these taxes.

### NOTE

- The tax status of PLU/subdepartment depends on the tax status of the department which the PLU/subdepartment belongs to.
- VAT/tax assignment symbol can be printed at the fixed right position near the amount on the receipt as follows:

VAT1/tax1 → A  
 VAT2/tax2 → B  
 VAT3/tax3 → C  
 VAT4/tax4 → D

When the multiple VAT/tax is assigned to a department or a PLU, a symbol of the lowest number assigned to VAT/tax rate will be printed. For programming, please refer to "Various Function Selection Programming 1" (Job code 66) on page 56.

### Example

#### Key operation

(When the manual VAT 1 through 4 system is selected)

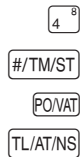

#### Print

1x 9.60	*9.60
DEPT. 04	
SUBTOTAL	*9.60
-----	
TAX1 ST	*9.60
VAT 1	*0.63
NET 1	*8.97
-----	
ITEMS 1Q	
CASH	<b>*9.60</b>



# OPTIONAL FEATURES

## 1 Auxiliary Entries

### ■ Percent calculations (premium or discount)

- Your register provides percent calculations for a subtotal or each item entry depending on the programming.
- Percentage: 0.01 to 100.00%

#### Percent calculation for a subtotal

##### Example

Key operation	Print																								
(When a discount of 10% is programmed for the <input type="text" value="4"/> key.)																									
<input type="text" value="4"/> <sup>8</sup>																									
<input type="text" value="4"/> <sup>8</sup>																									
<input type="text" value="#/TM/ST"/>																									
<input type="text" value=""/>																									
<input type="text" value="TL/AT/NS"/>																									
	<table border="1"> <tbody> <tr> <td>1x 9.60</td> <td></td> <td>*9.60</td> </tr> <tr> <td>DEPT. 04</td> <td></td> <td></td> </tr> <tr> <td>1x 9.60</td> <td></td> <td>*9.60</td> </tr> <tr> <td>DEPT. 04</td> <td></td> <td></td> </tr> <tr> <td>SUBTOTAL</td> <td></td> <td>*19.20</td> </tr> <tr> <td>%</td> <td>-10.00%</td> <td>-1.92</td> </tr> <tr> <td>ITEMS 2Q</td> <td></td> <td></td> </tr> <tr> <td>CASH</td> <td></td> <td><b>*17.28</b></td> </tr> </tbody> </table>	1x 9.60		*9.60	DEPT. 04			1x 9.60		*9.60	DEPT. 04			SUBTOTAL		*19.20	%	-10.00%	-1.92	ITEMS 2Q			CASH		<b>*17.28</b>
1x 9.60		*9.60																							
DEPT. 04																									
1x 9.60		*9.60																							
DEPT. 04																									
SUBTOTAL		*19.20																							
%	-10.00%	-1.92																							
ITEMS 2Q																									
CASH		<b>*17.28</b>																							

#### Percent calculation for item entries

##### Example

Key operation	Print																								
(When a premium of 15% is programmed for the <input type="text" value="30"/> key.)																									
<input type="text" value="4"/> <sup>8</sup>																									
<input type="text" value=""/>																									
<input type="text" value="30"/> <sup>PLU</sup>																									
<input type="text" value="750"/> <sup>PLU</sup>																									
<input type="text" value="TL/AT/NS"/>																									
	<table border="1"> <tbody> <tr> <td>1x 9.60</td> <td></td> <td>*9.60</td> </tr> <tr> <td>DEPT. 04</td> <td></td> <td></td> </tr> <tr> <td>%</td> <td>15.00%</td> <td>*1.44</td> </tr> <tr> <td>1x 5.00</td> <td></td> <td>*5.00</td> </tr> <tr> <td>PLU. 030</td> <td></td> <td></td> </tr> <tr> <td>%</td> <td>7.50%</td> <td>*0.38</td> </tr> <tr> <td>ITEMS 2Q</td> <td></td> <td></td> </tr> <tr> <td>CASH</td> <td></td> <td><b>*16.42</b></td> </tr> </tbody> </table>	1x 9.60		*9.60	DEPT. 04			%	15.00%	*1.44	1x 5.00		*5.00	PLU. 030			%	7.50%	*0.38	ITEMS 2Q			CASH		<b>*16.42</b>
1x 9.60		*9.60																							
DEPT. 04																									
%	15.00%	*1.44																							
1x 5.00		*5.00																							
PLU. 030																									
%	7.50%	*0.38																							
ITEMS 2Q																									
CASH		<b>*16.42</b>																							

**NOTE** Availability of item % and/or subtotal % depends on the programming data of the  key on page 46.

### ■ Printing of non-add code numbers

Enter a non-add code number such as a guest code number within a maximum of 16 digits and press the  key at any point during the entry of a sale. The non-add code is printed on the receipt.

##### Example

Key operation	Print															
1230 <input type="text" value="#/TM/ST"/>																
700 <input type="text" value=""/>																
<input type="text" value="CR"/>																
	<table border="1"> <tbody> <tr> <td>#0000000000001230</td> <td></td> <td></td> </tr> <tr> <td>1x 7.00</td> <td></td> <td>*7.00</td> </tr> <tr> <td>DEPT. 02</td> <td></td> <td></td> </tr> <tr> <td>ITEMS 1Q</td> <td></td> <td></td> </tr> <tr> <td>CREDIT</td> <td></td> <td><b>*7.00</b></td> </tr> </tbody> </table>	#0000000000001230			1x 7.00		*7.00	DEPT. 02			ITEMS 1Q			CREDIT		<b>*7.00</b>
#0000000000001230																
1x 7.00		*7.00														
DEPT. 02																
ITEMS 1Q																
CREDIT		<b>*7.00</b>														

## 2 Auxiliary Payment Treatment

### ■ Currency exchange

Your register allows payment entries in foreign currency. Press the **[EX]** key to create a subtotal in foreign currency.

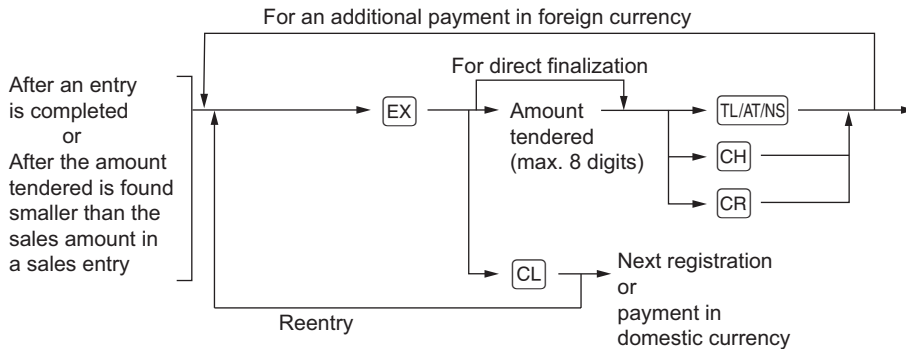

(Exchange rate: 0.000000 to 999.999999)

- NOTE**
- When the amount tendered is short, its equivalent in deficit is shown in domestic currency.
  - Change amount will be displayed in domestic currency.
  - Availability of credit and cheque tendering depends on the programming on page 63.
  - If programmed, a foreign currency symbol is printed when you use a preset rate. Refer to "Foreign currency symbol" on page 49 for the programming.

#### Example

**Key operation**

2300 **[2]**<sup>0</sup>  
 4650 **[1]**<sup>5</sup>  
 Currency exchange → **[EX]**  
 Amount → 10000 **[TL/AT/NS]**  
 (When a currency exchange rate of 0.939938 is programmed for the **[EX]** key.)

**Print**

1x 23.00	*23.00	
DEPT. 02		
1x 46.50	*46.50	
DEPT. 01		
ITEMS 2Q		
***TOTAL	<b>*69.50</b>	Domestic currency
EXCH	0.939938	Exchange rate
	US \$65.33	Foreign currency
CASH	US \$100.00	Foreign currency
CHANGE	*36.88	Domestic currency

Foreign currency symbol  
(Printed if programmed)

## ■ Received-on-account entries

When you receive on account from a customer, use the **RCPT/RA** key. For the received-on-account (RA) entry, enter the amount, and press the **RCPT/RA** key.

**NOTE** Cash tendering only available for RA operation.

### Example

Key operation	Print
12345 <b>#/TM/ST</b>	#0000000000012345
4800 <b>RCPT/RA</b>	***RA *48.00

## ■ Paid-out entries

When you pay an amount to a vendor, use the **PO/VAT** key. For the paid-out (PO) entry, enter the amount and press the **PO/VAT** key.

**NOTE** Cash tendering only available for PO operation.

### Example

Key operation	Print
54321 <b>#/TM/ST</b>	#0000000000054321
2300 <b>PO/VAT</b>	***PO *23.00

## ■ No sale (exchange)

When you need to open the drawer with no sale, press the **TL/AT/NS** key. The drawer will open and printer will print "NO SALE" on the receipt. If you let the register print a non-add code number before pressing the **TL/AT/NS** key, a no sale entry is achieved and a non-add code number is printed. Refer to "Other programming" (job code 63) on page 55 for the programming.

### Example

Key operation	Print
<b>TL/AT/NS</b>	#0000000000045678
	NO SALE

### 3 Special Printing Function

#### ■ After transaction receipt

In the OFF state (no receipting) of receipt ON-OFF function, the transaction receipt can be issued during item registrations or after finalizing a transaction (finalizing payment operations), press the **RCPT/RA** key to print it. However, the receipt printing is prohibited during payment operations.

##### Print sample (temporary EJ printing during a transaction)

22/10/12 18:32	000000#000115
3x 1.20	*3.60
DEPT.01	
1x 2.50	*2.50
DEPT.02	

##### Print sample (after finalizing a transaction)

22/10/12 18:32	000000#000115
3x 1.20	*3.60
DEPT.01	
1x 2.50	*2.50
DEPT.02	
ITEMS 4Q	
CASH	*6.10

#### ■ Copy Receipt printing

Your register can also print the receipt (copy receipt) after transaction receipt printing, press the **RCPT/RA** key to print a copy receipt. However, the receipt printing is prohibited during payment operations.

##### Print sample (after finalizing a transaction)

22/10/12 18:32	000000#000115
* COPY *	
3x 1.20	*3.60
DEPT.01	
1x 2.50	*2.50
DEPT.02	
ITEMS 4Q	
CASH	*6.10

**NOTE** When "copy receipt; no" (job code 63 on page 55) is programmed, the copy receipt function is prohibited.

# PRIOR TO PROGRAMMING

## ■ Procedure for programming

1. Check to see whether a paper roll is present in the machine. If there is not enough paper on a roll, replace it with a new one (refer to “Replacing the Paper Roll” in “OPERATOR MAINTENANCE” chapter on page 78 for the replacement).
2. Put the mode key in the mode switch and turn it to the Z/PGM position.
3. Program necessary items into the cash register. Every time you program an item, the cash register will print the setting. Please refer to print samples in each section.
4. If necessary, issue programming reports for your reference.

### NOTE

- On the key operation example shown in the programming details, numbers such as “221012” indicates the parameter which must be entered using the corresponding numeric keys.
- Asterisks in the tables shown in the programming details indicate default settings.

## ■ Entering character codes with numeric keys on the keyboard

Numerals, letters and symbols are programmable by entering the  key and character codes. Use the following procedure.

→ XXX →       XXX : character code (3 digits)

For the character codes, please refer to the character code table on the next page. By doing this, you can program characters other than those on the key tops. For entering numerals and letters using character keys, refer to “Guidance for text programming”.

- Double-size characters can be made by entering the character code 255 or pressing the  key. The “\_” symbol lights up in the display when double-size characters entry is selected as shown in the example below.
- **All three digits of the character code must be entered (even if it starts with zero).**

### Example

To program the word “SHARP” in double-size characters

255  083  255  072  255  065  255  082  255  080

          S                  H                  A                  R                  P

## ■ Alphanumeric character code table

032 - 047	032	033	034	035	036	037	038	039	040	041	042	043	044	045	046	047
		!	"	#	\$	%	&	'	(	)	*	+	,	-	.	/
048 - 063	048	049	050	051	052	053	054	055	056	057	058	059	060	061	062	063
	0	1	2	3	4	5	6	7	8	9	:	;	<	=	>	?
064 - 079	064	065	066	067	068	069	070	071	072	073	074	075	076	077	078	079
	@	A	B	C	D	E	F	G	H	I	J	K	L	M	N	O
080 - 095	080	081	082	083	084	085	086	087	088	089	090	091	092	093	094	095
	P	Q	R	S	T	U	V	W	X	Y	Z	[	\	]	^	_
096 - 111	096	097	098	099	100	101	102	103	104	105	106	107	108	109	110	111
	`	a	b	c	d	e	f	g	h	i	j	k	l	m	n	o
112 - 127	112	113	114	115	116	117	118	119	120	121	122	123	124	125	126	127
	p	q	r	s	t	u	v	w	x	y	z	{		}	~	Δ
128 - 143	128	129	130	131	132	133	134	135	136	137	138	139	140	141	142	143
	Ç	ü	é	â	ä	à	ã	ç	ê	ë	è	ï	î	ì	Ä	Å
144 - 159	144	145	146	147	148	149	150	151	152	153	154	155	156	157	158	159
	É	æ	ƒ	ô	ö	ò	û	ù	ÿ	ö	ü	ø	£	Ø	x	f
160 - 175	160	161	162	163	164	165	166	167	168	169	170	171	172	173	174	175
	á	í	ó	ú	ñ	Ñ	ª	º	¿	®	€	½	¼	¡	«	»
176 - 191	176	177	178	179	180	181	182	183	184	185	186	187	188	189	190	191
	⋮	⋮	⋮		đ	Á	Â	À	©	ě		ñ	ž	č	¥	š
192 - 207	192	193	194	195	196	197	198	199	200	201	202	203	204	205	206	207
	ť	ů	ž	č	-	ď	ã	ã	ě	ň	ř	š	ř	=	ó	ø
208 - 223	208	209	210	211	212	213	214	215	216	217	218	219	220	221	222	223
	š	Đ	Ê	Ë	È	€	Í	Î	Ï	Ž	Γ	■	■	!	ì	■
224 - 239	224	225	226	227	228	229	230	231	232	233	234	235	236	237	238	239
	Ó	β	Ô	Ò	Õ	Ö	μ	ρ	ρ	Ú	Û	Ù	Ú	Ý	-	'
240 - 255	240	241	242	243	244	245	246	247	248	249	250	251	252	253	254	255
	-	±	=	¾	¶	§	÷	¸	°	¨	.	1	3	2	■	(DC)

\*(DC) : Double-size character code

# AUXILIARY FUNCTION PROGRAMMING

## 1 Miscellaneous Key Programming

The cash register provides miscellaneous keys such as **%**, **RCPT/RA**, **PO/VAT**, **EX**, **CH**, **CR** and **TL/AT/NS**.

### Rate for **%** and **EX**

#### Procedure

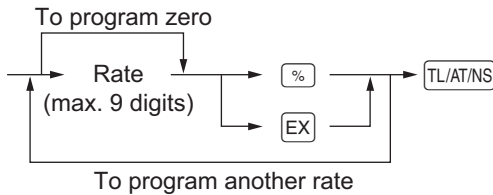

Rate:

XXXXX: 0.00 – 100.00 (% rate) (For example: 15.00%. enter 1500.)

XXXXXXXXXX: 0.000000 – 999.999999 (Currency exchange rate)

#### Example

Key operation	Print
1025 <b>%</b> (0.939938) → 939938 <b>EX</b> <b>TL/AT/NS</b>	<pre> *PGM* F01 %          00 L100.00%      -10.25% ← Percent rate F29 EXCH      02               0.939938 ← Currency                           exchange rate                     </pre>

### Percent rate limitation for **%**

You can program the upper limit of percent rates for percent entries.

**NOTE** This function is activated, when "HALO function; valid" (job code 62 on page 55) is programmed.

#### Procedure

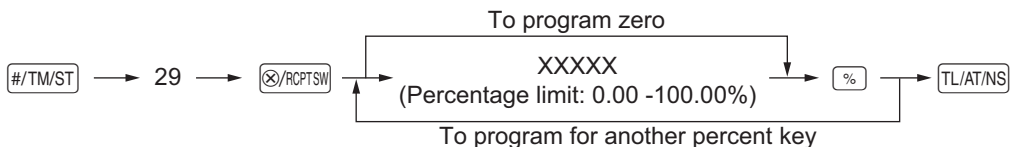

#### Example

Key operation	Print
#/TM/ST 29 <b>⊗/RCPTSW</b> (15.00%) → 1500 <b>%</b> <b>TL/AT/NS</b>	<pre> *PGM* F01 %          00 L 15.00%      -10.25%                 ← Percentage limit                     </pre>

## ■ Function parameters for %

### Procedure

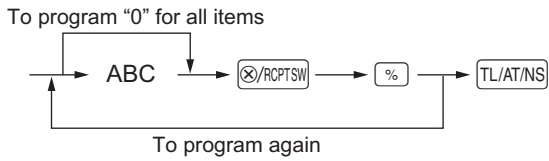

Item:	Selection:	Entry:
<b>A</b> +/- sign	+ (premium) sign	0
	- (discount) sign*	1
<b>B</b> Item %	Allow*	0
	Disallow	1
<b>C</b> Subtotal %	Allow*	0
	Disallow	1

### +/- sign

- Programming of the +/- sign assigns the premium or discount function.

### Item %

- Percent calculation for the individual department and PLU/subdepartment.

### Subtotal %

- Percent calculation for the subtotals.

### Example

#### Key operation

100 ⊗/RCPTSW  
 %  
 TL/AT/NS

#### Print

```

  *PGM*
  F 01 %          00
  L 15.00%       -10.25%
  
```

From left, BC  
 Sign (A)



## ■ Function parameters for EX

### Procedure

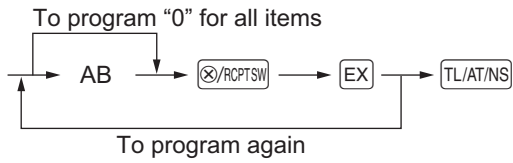

Item:	Selection:	Entry:
<b>A</b> <span style="border: 1px solid black; padding: 2px;">EX</span> key function	Allow*	0
	Disallow	1
<b>B</b> Position of decimal point (from right: tab)		0-3 (default: 2)

### Example

#### Key operation

02 ⊗/RCPTSW  
EX  
TL/AT/NS

#### Print

**\*PGM\***

F29 EXCH                      02

                                 0.939938

From left, AB

## ■ Function parameters for **RCPT/RA**, **PO/VAT**, **CH**, **CR** and **TL/AT/NS** key function

### Procedure

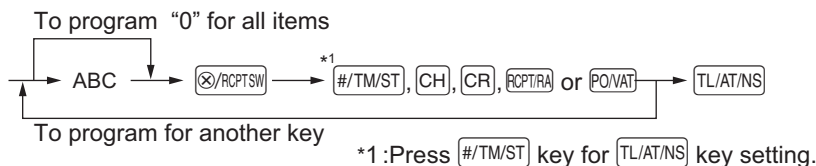

Item:	Selection:	Entry:
<b>A</b> Footer printing*2	Allow	1
	Disallow*	0
<b>B</b> Amount tendered entry*2	Compulsory	1
	Non-compulsory (for <b>CH</b> and <b>TL/AT/NS</b> )*	0
	Inhibit (for <b>CR</b> )*	0
<b>C</b> Entry digit limit	For <b>CH</b> , <b>CR</b> and <b>TL/AT/NS</b>	0-8 (default: 8)
	For <b>RCPT/RA</b> and <b>PO/VAT</b>	0-9 (default: 9)

\*2: When programming for **RCPT/RA** or **PO/VAT**, always enter 0 for item(A) and item(B)

### Footer printing (only for **CH**, **CR** and **TL/AT/NS**)

- This programming decides whether or not the machine should print a message at the foot of a receipt when a specified media key is used. With regard to programming method of footer logo message, refer to "Logo messages" section.

### Amount tendered entry (only for **CH**, **CR** and **TL/AT/NS**)

- You may select amount tendered, compulsory or optional, for the **CH**, and **TL/AT/NS** keys.
- You may select amount tendered, compulsory or inhibited, for the **CR** key.

### Entry digit limit

- For the **CH**, **CR**, **RCPT/RA** and **PO/VAT** keys program upper limit entry amount for the tendered amount. For the **TL/AT/NS** key, program upper limit entry for total cash amount which can be handled on the register. The entry digit limit is represented by the number of allowable digits for the maximum entry or total amount. When "0" is set, the operation of the corresponding key is prohibited.

**NOTE** This function is activated, when "HALO function; valid" (job code 62 on page 55) is programmed.

### Example

#### Key operation

018 **RCPT/RA**  
**CH**  
**TL/AT/NS**

#### Print

**\*PGM\***  
**F24 CHECK**      018 —From left, ABC

## 2 Other Text Programming

Please refer to “Guidance for text programming” on page 12 or “Entering character codes with numeric keys on the keyboard” on page 43 as for how to entering characters.

### ■ Foreign currency symbol (4 characters)

Foreign currency symbol for the **[EX]** key is printed with a foreign currency exchange amount obtained using a preset rate.

#### Procedure

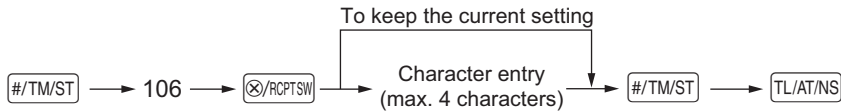

#### Example

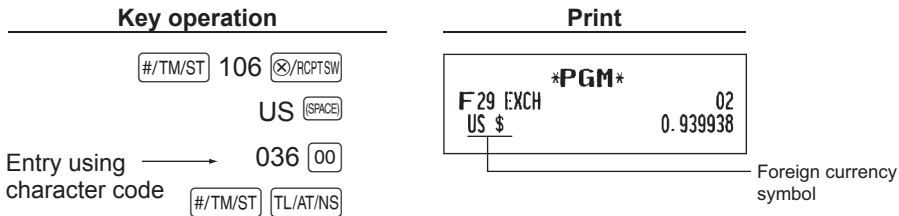

(U:0 <sup>7</sup><sub>3 u-z</sub>, S:8 <sup>6</sup><sub>2 k-T</sub>)

### ■ Domestic currency symbol (4 characters)

“\*” is set as a default setting. When you want to change the domestic currency symbol, change the setting.

#### Procedure

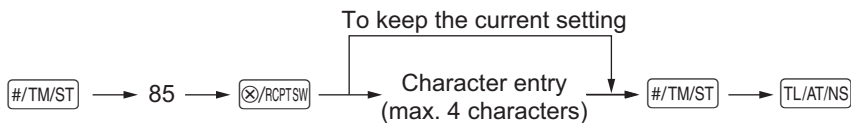

#### Example

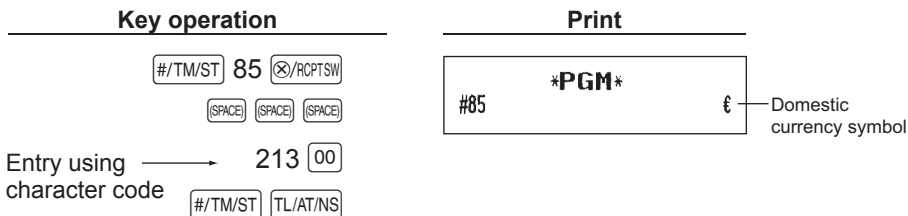

## ■ Function text (12 characters)

### Procedure

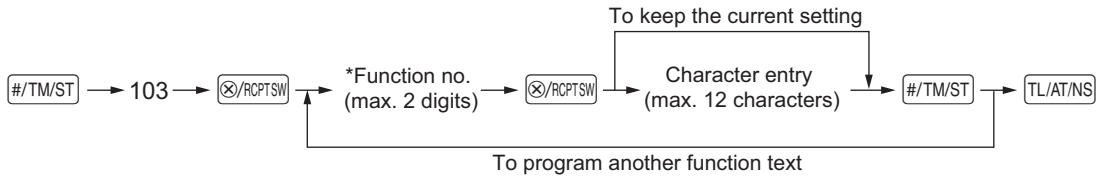

\* Function no.: See “List of function texts” shown on the following page.

### Example

#### Key operation

#/TM/ST 103 ⓧ/RCPTSW  
 25 ⓧ/RCPTSW  
 CARD #/TM/ST  
 TL/AT/NS

#### Print

<b>*PGM*</b>		
F 25 CARD	008	

Programming “CARD” for credit

(C:2  $\begin{matrix} 5 \\ \boxed{1 \text{ A-J}} \end{matrix}$ , A:0  $\begin{matrix} 5 \\ \boxed{1 \text{ A-J}} \end{matrix}$ , R:7  $\begin{matrix} 6 \\ \boxed{2 \text{ K-T}} \end{matrix}$ , D:3  $\begin{matrix} 5 \\ \boxed{1 \text{ A-J}} \end{matrix}$ )

## ■ List of function texts

Function no.	Key or function	Default setting
1	%	%
2	Differ	DIFFER
3	Taxable 1 subtotal	TAX1 ST
4	Taxable 2 subtotal	TAX2 ST
5	Taxable 3 subtotal	TAX3 ST
6	Taxable 4 subtotal	TAX4 ST
7	VAT/tax 1	VAT 1
8	VAT/tax 2	VAT 2
9	VAT/tax 3	VAT 3
10	VAT/tax 4	VAT 4
11	Total tax	TTL TAX
12	Net without tax	<b>NET</b>
13	Net 1	<b>NET 1</b>
14	Net 2	<b>NET 2</b>
15	Void	VOID
16	Void mode total	VOID MODE
17	Subtotal void	SBTL VOID
18	No sale	NO SALE
19	Starting cash memory (+)	SCM(+)
20	Starting cash memory (-)	SCM(-)
21	RA	<b>***RA</b>
22	PO	<b>***PO</b>
23	Cash	<b>CASH</b>
24	Cheque	CHECK
25	Credit	CREDIT
26	Customer (transaction count)	GUEST
27	Paid total	PAID TL

Function no.	Key or function	Default setting
28	Average	AVE.
29	Exchange (Preset rate)	EXCH
30	Exchange cheque	EX CHK
31	Exchange credit	EX CR
32	Domestic currency	DOM.CUR
33	Dom. currency for EX cheque	DOM.CUR CHK
34	Dom. currency for EX credit	DOM.CUR CR
35	Cash in drawer	<b>***CID</b>
36	Cheque in drawer	<b>*CH ID</b>
37	Cash/cheque in drawer	CA/CHK ID
38	Change for cheque	CHK/CG
39	(+) Dept total	<b>*DEPT TL</b>
40	(-) Dept total	DEPT (-)
41	Total	<b>***TOTAL</b>
42	Subtotal	SUBTOTAL
43	Starting cash memory total	SCM TTL
44	Merchandise subtotal	MDSE ST
45	Non add symbol (8 chara.)	#
46	Sales q'ty	ITEMS
47	Change	CHANGE
48	Net 1 (Taxable 1 - VAT/tax 1)	NET 1
49	Net 2 (Taxable 2 - VAT/tax 2)	NET 2
50	Net 3 (Taxable 3 - VAT/tax 3)	NET 3
51	Net 4 (Taxable 4 - VAT/tax 4)	NET 4
52	Copy receipt title	<b>COPY</b>

# ADVANCED FUNCTION PROGRAMMING

## 1 Register Number and Consecutive Number Programming

The register number and consecutive numbers are printed on every receipt.

When your store has two or more registers, it is practical to set separate register numbers for identification. The consecutive number is increased by one each time a receipt is issued.

For consecutive number programming, enter a number (max. 6 digits) that is one less than the desired starting number.

### Register number

#### Procedure

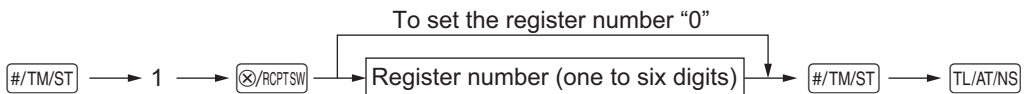

#### Example

##### Key operation

#/TM/ST 1 ⊗/RCPTSW  
123456 #/TM/ST TL/AT/NS

##### Print

#1 \*PGM\* 123456 — Register number

### Consecutive number

#### Procedure

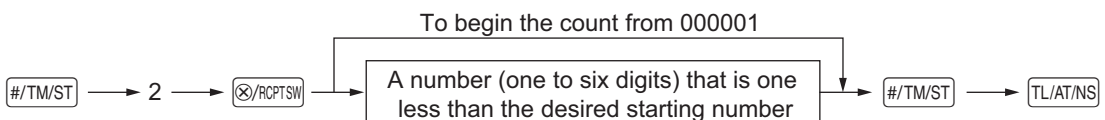

#### Example

##### Key operation

#/TM/ST 2 ⊗/RCPTSW  
100000 #/TM/ST TL/AT/NS

##### Print

#2 \*PGM\* 100000 — Consecutive number

## 2 Various Function Selection Programming 1

The cash register provides various detailed functions listed below.

- Print format
- Receipt print format
- Others

For this programming, the job code entry style is applied. You can continue programming until you press the **TL/AT/NS** key for the programming described in this section. To continue programming, repeat from a job code entry.

### Procedure

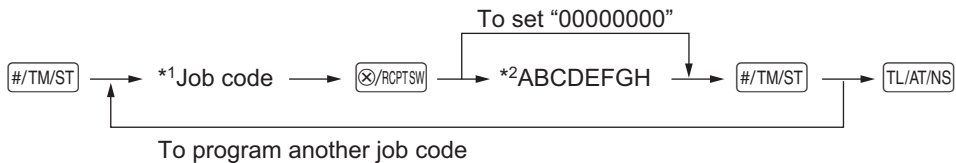

\*1 Enter job code using numeric keys specified in each section below.

\*2 Data entry details are listed on each table in each section below. An asterisk is entered for factory setting.

**Example** When programming for job code 6 as ABCDEFGH: 0000111.

#### Key operation

#/TM/ST 6 ⊗/RCPTSW  
0000111 #/TM/ST TL/AT/NS

#### Print

```
#6      *PGM*
        0000111
```

## Print format

Job code: 6

Item:	Selection:	Entry:
<b>A</b> Always enter 0.		0
<b>B</b> Always enter 0.		0
<b>C</b> Time print on all receipts	Yes*	0
	No	1
<b>D</b> Date print on all receipts	Yes*	0
	No	1
<b>E</b> Consecutive no. print	Yes*	0
	No	1
<b>F</b> Separator line in reports	One line space	0
	Separator line*	1
<b>G</b> Zero skip in PLU report	No	0
	Yes*	1
<b>H</b> Zero skip in full sales/hourly reports	No	0
	Yes*	1

## ■ Receipt print format

Job code: 7

Item:	Selection:	Entry:
<b>A</b>	Always enter 0.	0
<b>B</b>	Always enter 0.	0
<b>C</b>	Subtotal print with a press of subtotal key	No*
		Yes
<b>D</b>	Always enter 0.	0
<b>E</b>	VAT/tax amount print	Yes*
		No
<b>F</b>	Taxable amount print	Yes*
		No
<b>G</b>	Net amount print	Yes*
		No
<b>H</b>	Purchase no. print	Yes*
		No

## ■ Other programming

Job code: 61

Item:	Selection:	Entry:
<b>A</b>	Punctuation for print	No*
	When <b>H</b> is "0", the punctuation mark (.) is printed by each 3 digits (ex: 1.200.300).	Yes
<b>B</b>	Always enter 0.	0
<b>C</b>	Always enter 0.	0
<b>D</b>	Fractional treatment	Round off (4 down, 5 up)*
		Raising to unit
		Disregarding fractional treatment
<b>E</b>	Always enter 0.	0
<b>F</b>	Time format	12-hour format
		24-hour format*
<b>G</b>	Date format	Use month-day-year format
		Use day-month-year format*
		Use year-month-day format
<b>H</b>	Position of decimal point (from right) (TAB)	0 to 3 (default: 2)



**Job code: 62**

<b>Item:</b>	<b>Selection:</b>	<b>Entry:</b>
<b>A</b> HALO function	Invalid*	0
	Valid	1
<b>B</b> Always enter 0.		0
<b>C</b> Always enter 0.		0
<b>D</b> Buffered keyboard	Yes*	0
	No	1
<b>E</b> Always enter 0.		0
<b>F</b> Printing of void mode in X2/Z2 report	Yes*	0
	No	1
<b>G</b> Printing of void mode in X1/Z1 report	Yes*	0
	No	1
<b>H</b> Addition to the hourly total in VOID mode	No*	0
	Yes	1

**Job code: 63**

<b>Item:</b>	<b>Selection:</b>	<b>Entry:</b>
<b>A</b> Receipting at the time of "no sale" entry	Yes*	0
	No	1
<b>B</b> No sale after non-add code entry	Disable	0
	Enable*	1
<b>C</b> Non-add code entry	Enable*	0
	Disable	1
<b>D</b> Copy receipt	No	0
	Yes*	1
<b>E</b> Entry that causes the merchandise subtotal to be smaller than zero	Enable*	0
	Disable	1
<b>F</b> Subtotal entry before tendering	Noncompulsory*	0
	Compulsory	1
<b>G</b> Subtotal entry before direct non-tender finalization	Noncompulsory*	0
	Compulsory	1
<b>H</b> Direct non-tender finalization after tendering	Disable	0
	Enable*	1

**Job code: 64**

<b>Item:</b>	<b>Selection:</b>	<b>Entry:</b>
<b>A</b> Printing of GT1 on Z report	Yes*	0
	No	1
<b>B</b> Printing of GT2 on Z report	Yes*	0
	No	1
<b>C</b> Printing of GT3 on Z report	Yes*	0
	No	1
<b>D</b> Always enter 0.		0
<b>E</b> Printing of Z counter on Z report	Yes*	0
	No	1
<b>F</b> Printing of DATA on PLU resetting report	Yes*	0
	No	1
<b>G</b> Resetting of GT1, 2, 3 at the general Z1 report	No*	0
	Yes	1
<b>H</b> Always enter 0.		0

**Job code: 65**

<b>Item:</b>	<b>Selection:</b>	<b>Entry:</b>
<b>A</b> Printing of GT1 on X report	No*	0
	Yes	1
<b>B</b> Printing of GT2 on X report	No*	0
	Yes	1
<b>C</b> Printing of GT3 on X report	No*	0
	Yes	1
<b>D</b> Starting cash memory input	Non-compulsory*	0
	Compulsory	1
<b>E</b> Always enter 0.		0
<b>F</b> Always enter 0.		0
<b>G</b> Always enter 0.		0
<b>H</b> Always enter 0.		0

**Job code: 66**

<b>Item:</b>	<b>Selection:</b>	<b>Entry:</b>
<b>A</b> After transaction receipt	Total only	0
	Details*	1
<b>B</b> Amount printing when PLU unit price is zero	No*	0
	Yes	1
<b>C</b> Always enter 0.		0
<b>D</b> VAT/tax assignment print	Yes	0
	No*	1
<b>E</b> Always enter 0.		0
<b>F</b> Always enter 0.		0
<b>G</b> Logo text print on journal	No*	0
	Yes	1
<b>H</b> Footer print control	All receipts*	0
	Only on selected function key at the time of finalization	1

**Job code: 67**

<b>Item:</b>	<b>Selection:</b>	<b>Entry:</b>
<b>A</b> Rounding amount printing	No*	0
	Yes	1
<b>B</b> Total amount rounding when a transaction is finalized directly by <input type="checkbox"/> CH or <input type="checkbox"/> CR key	Rounding*	0
	Not rounding	1
<b>C</b> Rounding up of the unit digit of amount		0 - 9 (default: 0)
<b>D</b> Rounding down of the unit digit of amount		0 - 9 (default: 0)
<b>E</b> Application of rounding	Item and payment*	0
	Payment	1
<b>F</b> Limit of the least significant digit in entering amount of item	Arbitrary*	0
	0 only	1
	0 and 5 only	2
<b>G</b> Memory of difference due to rounding	No*	0
	Yes	1
<b>H</b> Limit of the least significant digit in entering amount of payment	Arbitrary*	0
	0 only	1
	0 and 5 only	2

**Rounding amount printing (A)**

**Total amount rounding when a transaction is finalized directly by CH or CR key (B)**

**Rounding up of the unit digit of amount (C)**

**Rounding down of the unit digit of amount (D)**

- Handle C and D as a pair.

The rounding is performed as follows:

In case C = 0: Unit digit of amount < or = Value of D — rounding down

Value of D < or = Unit digit of amount — rounding to 5

In other cases: Unit digit of amount < or = Value of D — rounding down

Value of D < Unit digit of amount < Value of C — rounding to 5

Value of C < or = Unit digit of amount — rounding up

**Application of rounding (E)**

**Limit of the least significant digit in entering amount of item (F)**

**Memory of difference due to rounding (G)**

**Limit of the least significant digit in entering amount of payment (H)**

<Example>

<b>CD</b>	<b>E</b>	<b>F</b>	<b>G</b>	<b>H</b>
82	Item & payment	0 and 5 only	No	0 and 5 only
54	Payment	Arbitrary	Yes	0 only

**Job code: 68**

<b>Item:</b>	<b>Selection:</b>	<b>Entry:</b>
<b>A</b>	Printing data on EJ Z report	No
		Yes*
<b>B</b>	Always enter 0.	0
<b>C</b>	Temporary EJ printing during a transaction	Disable
		Enable*
<b>D</b>	Always enter 0.	0
<b>E</b>	PGM mode operation records type	Details*
		Header information only
<b>F</b>	REG/VOID modes operation records type	Details*
		Total
<b>G</b>	Compressing printing for EJ data	No (normal size)
		Yes (small size)*
<b>H</b>	Action when EJ memory area is full	Continue
		Continue and warning (with near full warning)*
		Lock and warning
		Lock and warning (with near full warning)

**Printing data on EJ Z report**

- Select “No” to issue an EJ Z report without printing the journal data on it.

**Temporary EJ printing during a transaction**

- If selecting “enable”, you can print journal data of a current transaction recorded in EJ memory by pressing the  key during the transaction. To realize this function completely, the cash register must be programmed to print the receipt and set the Receipt ON/OFF function to OFF.

**PGM mode operation records type**

- The header information only is recorded during the program reading operation.  
The header information only is recorded for X/Z reports.

**Action when EJ memory area is full**

- By default, when the memory for EJ becomes nearly full, the cash register shows decimal points at the 7th and 8th positions of the display (EJ memory nearly full warning), and the cash register keeps storing new data while erasing the oldest data. When “0” is selected, the cash register will no longer show EJ memory nearly full warning. When “2” is selected, the cash register shows EJ memory nearly full warning and when the memory is totally full, the cash register locks the sales/data entry with a display of the memory full error “ $\bar{E}-\bar{E}$ ”. You must issue an EJ report (Z1 report) at this time.

**Job code: 69**

<b>Item:</b>	<b>Selection:</b>	<b>Entry:</b>
<b>A</b>	Always enter 0.	0
<b>B</b>	Always enter 0.	0
<b>C</b>	Always enter 0.	0
<b>D</b>	Rounding of foreign currency for <input type="checkbox"/> EX	Rising to unit*
		Round off (4 down/5 up)
<b>E</b>	Tax system	Auto tax 1-4
		Auto VAT 1-4*
		Manual VAT 1-4
		Manual VAT 1
		Manual tax 1-4
		Auto VAT 1 & Auto tax 2-4
<b>F</b>	Tax print when taxable subtotal is zero	No*
		Yes
<b>G</b>	Tax print when tax is zero	Yes*
		No
<b>H</b>	Smallest coin (for rounding system)	Normal*
		25
		50
		100

**NOTE** For (H) smallest coin (for rounding system), as follows;

H=25

Lowest 2 digits	Lowest 2 digits after rounding
0 - 12	00
13 - 37	25
38 - 62	50
63 - 87	75
88 - 99	00 (i.e. rounded up to 100)

H=50

Lowest 2 digits	Lowest 2 digits after rounding
0 - 24	00
25 - 74	50
75 - 99	00 (i.e. rounded up to 100)

H=100

Lowest 2 digits	Lowest 2 digits after rounding
0 - 49	00
50 - 99	00 (i.e. rounded up to 100)

**Job code: 16 (Control unit (only available in specific countries))**

Item:		Selection:	Entry:
<b>A</b>	Type	Cash Control Unit (G&D)*	0
		Clean Cash (RI)	1
<b>B</b>	Transmission speed ,(bps)	9600*	0
		19200	1
		38400	2
<b>C - H</b>	Inhibited	-	-

**■ Miscellaneous data**

**Procedure**

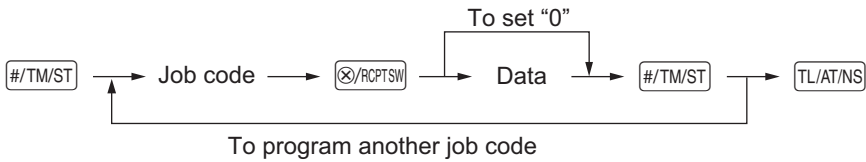

- Job code: 71 (GT2)**                      Data: GT2 (max. 13 digits: 0 - 9999999999999)
- Job code: 72 (GT3)**                      Data: GT3 (max. 13 digits: 0 - 9999999999999)
- Job code: 76 (Z1 counter)**              Data: Z1 counter (max. 4 digits: 0 - 9999)
- Job code: 77 (Z2 counter)**              Data: Z2 counter (max. 4 digits: 0 - 9999)
- Job code: 612 (VAT ID (only available in specific countries))**      Data: VAT ID (max. 9 or 10 digits:  
0 – 999999999 or 9999999999)

### 3 Various Function Selection Programming 2

The cash register provides various options so you can use the register to suit your sales needs.

In this section, you can program the following features (parameters within parentheses indicate default setting):

- Power save mode (entering the power save mode after 30 minutes)
- Logo message print format (Header 3-line message and footer 3-line message)
- Save SD function
- Thermal printer density (standard density)

#### ■ Power save mode

##### Procedure

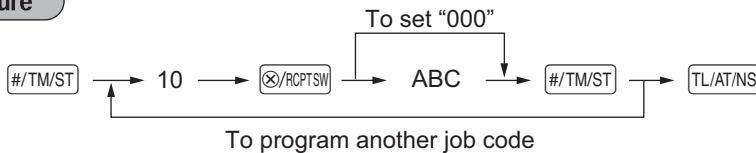

Item:	Selection:	Entry:
<b>A</b> Entering power save mode when time is displayed	Yes*	0
	No	1
<b>BC</b> Time (minute) to entering power save mode since no operation is made		00 to 99 (default 30) (00: 100 minutes)

##### Example

##### Key operation

#/TM/ST 10 ⊗/RCPTSW  
030 #/TM/ST TL/AT/NS

##### Print

```
#10      *PGM*      030
```

#### ■ Logo message print format

You can select the number of lines for your logo message, and the position to print it on receipt.

For details of the logo message type, please refer to "Logo messages" section on "Text Programming".

##### Procedure

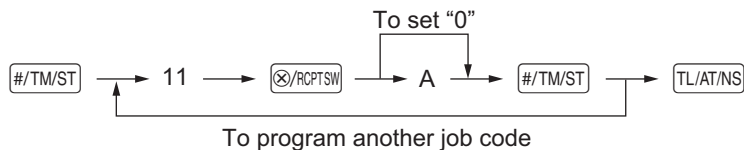

A: Logo message type

0: Header 3-line message without graphic logo

1: Graphic logo only

2: Graphic logo and footer 3-line message

3: Header 6-line message

4: Graphic logo and header 3-line message

5: Header 3-line message and footer 3-line message (default\*)

##### Example

##### Key operation

#/TM/ST 11 ⊗/RCPTSW  
3 #/TM/ST TL/AT/NS

##### Print

```
#11      *PGM*      3
```

## ■ Save SD function

### Procedure

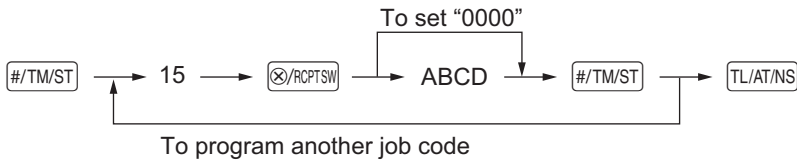

Item:	Selection:	Entry:
<b>A</b> Save all RAM data in the SD card at general Z1 report	No*	0
	Yes	1
<b>B</b> Save sales data in the SD card at general Z1 report	No*	0
	Yes	1
<b>C</b> Save Electronic Journal data in the SD card at general Z1 report	Not to save EJ data and not to clear*	0
	Not to save EJ data and clear	1
	Save EJ data and clear	2
<b>D</b> Control characters (when EJ data is saved in the SD card.)	Non-convert*	0
	Convert to space code (0x20)	1

### Example

#### Key operation

#/TM/ST 15 ⓧ/RCPTSW  
100 #/TM/ST TL/AT/NS

#### Print

#15 \*PGM\* 0100

## ■ Thermal printer density

### Procedure

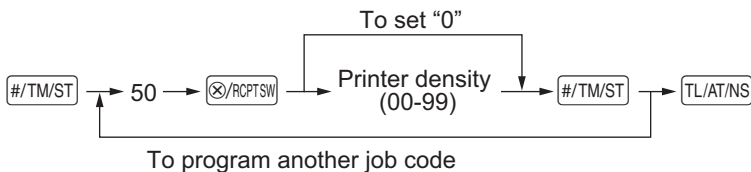

Printer density (00-99): Selecting light and shade  
 00 = 80% for printer standard  
 50 = 90% for printer standard (default\*)  
 99 = 100% for printer standard

To make the print darker, set a larger number, and to make the print lighter, set a smaller number.

### Example

#### Key operation

#/TM/ST 50 ⓧ/RCPTSW  
70 #/TM/ST TL/AT/NS

#### Print

#50 \*PGM\* 70



## 4 EURO Programming

For details of EURO migration operation, please refer to “EURO MIGRATION FUNCTION”.

### ■ EURO system settings

#### Procedure

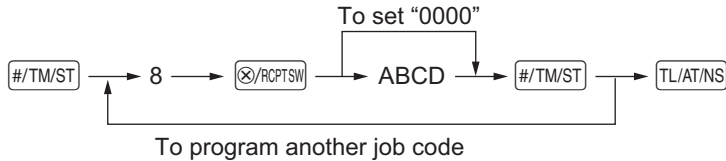

Item:	Selection:	Entry:
<b>A</b> Printing exchange total amount and change amount on receipt	No*	0
	Yes	1
<b>B</b> Always enter 0.		0
<b>C</b> Cheque and credit operation when tendering in foreign currency	No*	0
	Yes	1
<b>D</b> Exchange calculation method	Multiplication*	0
	Division	1

#### Printing exchange total amount and change amount on receipt

- Total and change amounts in exchange currency are printed respectively below each of the total and exchange amounts in domestic currency.

#### Exchange calculation method

- “Division” or “Multiplication” can be selected for the conversion method from domestic currency to exchange currency, and the calculation is performed as follows:

In case that “Division” is selected:

$$\text{Domestic currency amount} \div \text{Exchange rate} = \text{Exchange amount}$$

In case that “Multiplication” is selected:

$$\text{Domestic currency amount} \times \text{Exchange rate} = \text{Exchange amount}$$

#### Example

##### Key operation

```

#/TM/ST 8 ⊗/RCPTSW
1000 #/TM/ST
TL/AT/NS
    
```

##### Print

```

#8 *PGM* 1000
    
```

## Automatic EURO modification operation settings

### Procedure

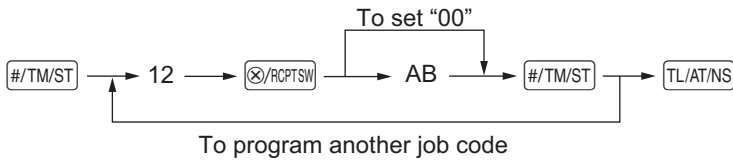

Item:	Selection:	Entry:
<b>A</b> Converting the preset unit price of Dept./PLU in the automatic modification operation for EURO (job #800 in the Z/PGM mode)	Yes*	0
	No	1
<b>B</b> Automatic modification operation for EURO (job #800 in the Z/PGM mode) at the preset date	Compulsory*	0
	Non-compulsory	1

### Example

#### Key operation

#/TM/ST 12  RCPTSW  
 01 #/TM/ST  
 TL/AT/NS

#### Print

#12 \*PGM\* 01

**NOTE** If you have already made the Job #800 operation with the substitution of 3 for “A” in the Z/PGM mode, this programming is disabled.

## Date setting for EURO modification operation

### Procedure

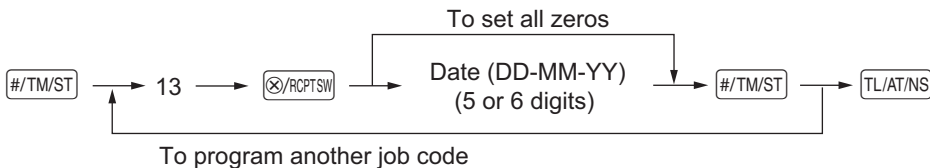

### Example

#### Key operation

#/TM/ST 13  RCPTSW  
 010113 #/TM/ST  
 TL/AT/NS

#### Print

#13 \*PGM\* 01/01/13

**NOTE**

- In case you changed the date format using job code 61, follow the format you selected for setting the date.
- If all zeros are set, this programming is disabled.
- If you have already made the Job #800 operation with the substitution of 3 for “A” in the Z/PGM mode, this programming is disabled.

## ■ Time setting for EURO modification operation

### Procedure

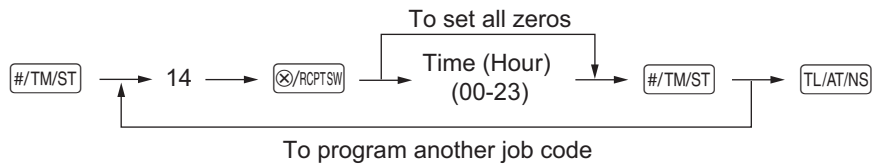

### Example

#### Key operation

#/TM/ST 14 ⊗/RCPTSW  
 10 #/TM/ST  
 TL/AT/NS

#### Print

#14	*PGM*	10:00
-----	-------	-------

**NOTE** If you have already made the Job #800 operation with the substitution of 3 for "A" in the Z/PGM mode, this programming is disabled.

## 5 Reading Stored Programs

The machine allows you to read every program stored in the Z/PGM mode.

### Key sequence for reading stored program

Report name	Key sequence
Programming report 1	1 → <span style="border: 1px solid black; padding: 2px;">TL/AT/NS</span>
Programming report 2	2 → <span style="border: 1px solid black; padding: 2px;">TL/AT/NS</span>
Printer density programming report	3 → <span style="border: 1px solid black; padding: 2px;">TL/AT/NS</span>
Department programming report	4 → <span style="border: 1px solid black; padding: 2px;">TL/AT/NS</span>
PLU programming report	5 → <span style="border: 1px solid black; padding: 2px;">TL/AT/NS</span> (Full reading)
ROM version report	6 → <span style="border: 1px solid black; padding: 2px;">TL/AT/NS</span>

Reading a start PLU

(Assigning a range) Start PLU code → ⊗/RCPTSW → End PLU code → ⊗/RCPTSW → 5 → TL/AT/NS

### Sample printouts

#### Programming report 1

FUNCTIONS	*PGM*	Mode
F01 %	00	Function no. & its text
L100.00%	-10.25%	Function parameters
F03 TAX1 ST		Percent rate with sign
F04 TAX2 ST		Percent limit
F05 TAX3 ST		
F06 TAX4 ST		
F07 VAT 1		
F08 VAT 2		
F09 VAT 3		
F10 VAT 4		
F11 TTL TAX		
F12 NET		
F13 NET1		
F14 NET2		
F15 VOID		
F16 VOID MODE		
F17 SBTL VOID		
F18 NO SALE		
F19 SCH(+)		
F20 SCH(-)		
F21 ***RA	9	Entry digit limit
F22 ***PO	9	Entry digit limit
F23 CASH	008	Function parameters (A-C)
F24 CHECK	018	Function parameters (A-C)
F25 CARD	008	Function parameters (A-C)
F26 GUEST		
F27 PAID TL		
F28 AVE.		
F29 EXCH	02	Foreign currency symbol/Rate
US \$	0.939938	Foreign currency symbol/Rate
F32 DOM. CUR		
F35 ****CID		
F36 *CH ID		
F37 CA/CHK ID		
F38 CHK/CG		

F39 *DEPT TL			
F40 DEPT (-)			
F41 ***TOTAL			
F42 SUBTOTAL			
F43 SCH TTL			
F44 MDSE ST			
F45 #			
F46 ITEMS			
F47 CHANGE			
F48 NET 1			
F49 NET 2			
F50 NET 3			
F51 NET 4			
F52 COPY			
<b>THANK YOU FOR YOUR PURCHASE WE ARE LOOKING FORWARD TO YOUR NEXT VISIT</b>			Logo Message
#6	00000111	Print format (A-H)	
#7	00000000	Receipt print format (A-H)	
#8	1000	EURO system settings (A-D)	
#10	030	Power save mode (A-C)	
#11	5	Logo message print format	
#12	01	Automatic EURO modification operation settings (AB)	
#13	01/01/13	Date setting for EURO modification operation	
#14	10:00	Date setting for EURO modification operation	
#15	0000	Time setting for EURO modification operation	
TAX1	7.0000%	SD card programming (A-D)	
TAX2	16.0000%		
TAX3	8.0000%		
TAX4	15.0000%		

Tax rate

### Programming report 2

*PGM*		
SYSTEM PRESET		
#61	00000112	Job code
#62	00000000	
#63	01010001	A to H from the left
#64	00000000	
#65	00000000	
#66	10010000	
#67	00000000	
#68	10100011	
#69	00002000	
#71		
GT2	€00000001021.51	
#72		
GT3	-00000000103.57	
#76	21 0006	
#77	22 0001	
#85	€	Domestic currency symbol
#88	0	Language selection

### Department programming report

*PGM*				
DEPARTMENT				
Dept. code	D01		0.01	Dept. unit price w/sign
Dept. text	DEPT. 01	T1	083	Dept. function
	D02		0.00	
	DEPT. 02	T1	081	
Tax status				
	D08		0.00	
	DEPT. 08	T1	081	

### PLU programming report

*PGM*				
PLU				
PLU code	P001 (01)		1	PLU/subdepartment selection
PLU text	PLU.001		3.28	Unit price
	P002 (01)		1	
	PLU.002		5.10	Associated dept. code
Tax status				
	PLU.199		0.00	
	P200 (01)		1	
	PLU.200		0.00	

### Printer density programming report

*PGM*		
DENSITY		
#50	70	Printer density (entered value)
10	: 0123456789AB	Printing density example
20	: 0123456789AB	
30	: 0123456789AB	
40	: 0123456789AB	
50	: 0123456789AB	
60	: 0123456789AB	
70	: 0123456789AB	
80	: 0123456789AB	
90	: 0123456789AB	

### ROM version report

*PGM*		
VERSION		
ROM Version	Ver1.00	Version number
	XE-A137/A147V	

# READING (X) AND RESETTING (Z) OF SALES TOTALS

- Use the reading function (X) when you need to take a reading of sales information entered since the last reset. You can take this reading any number of times. It does not affect the register's memory.
- Use the resetting function (Z) when you need to clear the register's memory. Resetting prints all sales information and clears the entire memory except for the GT1 through GT3, reset count, and consecutive number.

## 1 Summary of Reading (X) and Resetting (Z) Reports

X1 and Z1 reports: Daily sales reports

X2 and Z2 reports: Periodic (monthly) consolidation reports

When you take an X1 or X2 report, turn the mode switch to the X/Flash position, and use the corresponding key sequence.

When you take an Z1 or Z2 report, turn the mode switch to the Z/PGM position, and use the corresponding key sequence.

Item	Mode switch position		Key operation
	X/Flash	Z/PGM	
Full sales report			
Daily report (X1/Z1)	X1	Z1	[TL/AT/NS]
Periodic report (X2/Z2)	X2	Z2	[SHIFT] [TL/AT/NS]
PLU report	X1	Z1	<p>For all PLUs</p> <pre> graph LR     Start[Start PLU code] --&gt; Key([X/RCP/TSW])     Key --&gt; End[End PLU code]     End --&gt; PLU([PLU])     End --&gt; Start     End --&gt; StartPLU[For a start PLU]                     </pre>
Hourly report	X1	Z1	[∞]
Flash report (only display)			To clear the display, press the [CL] key or turn the mode switch to another position.
Department sales total	X1	—	For dept.1 to dept.4: [1 <sup>9</sup> ] to [4 <sup>9</sup> ] For dept.5 to dept.8: [SHIFT] [1 <sup>9</sup> ] to [SHIFT] [4 <sup>9</sup> ]
Cash in drawer total	X1	—	[CR]
Sales total	X1	—	[CH]

- NOTE**
- When both sales quantities and sales amounts are zero, printing is skipped. If you do not want to skip, change the programming. (Refer to "Print format" of "Various Function Selection Programming 1" on page 53.)
  - "X" represents read symbol and "Z" represents reset symbol in the reports.
  - To stop reading and resetting the PLU sales report, press the [ESC/HELP] key.  
The data will not be erased when you reset.
  - The drawer does not open when you take X/Z reports.  
The drawer can be opened by pressing the [TL/AT/NS] key in REG mode to remove it after closing your business.

## 2 Daily Sales Totals

For the sample reports of the full sales and periodic consolidation report, refer to “FULL SALES REPORT (X or Z REPORT)” on page 27-28.

### ■ PLU report by designated range

#### • Sample report

PLU		*X1*		Mode title*
		001- 030		Report title
PLU code	Item label			Range
P001			5 Q	Sales qty and total
PLU.001		*12.84		
P002			2 Q	Sales qty and total
PLU.002		*5.10		
P006			31 Q	Sales qty and total
PLU.006		*201.50		
P007			1 Q	Sales qty and total
PLU.007		*0.00		
P008			3 Q	Sales qty and total
PLU.008		*9.60		
P010			11 Q	Sales qty and total
PLU.010		*58.15		
P016			1 Q	Sales qty and total
PLU.016		*12.00		
P017			8 Q	Sales qty and total
PLU.017		*8.00		
P030			3 Q	Sales qty and total
PLU.030		*10.38		
***TOTAL			65 Q	Range sum
			*317.57	

### ■ Hourly report

#### • Sample report

HOURLY		*X1*		Mode title*
				Report title
8:00		19 Q		Customer counter
		*487.90		Sale total
AVE.		*25.68		Average (Sales total/Customer counter)
9:00		11 Q		
		*195.48		
AVE.		*17.77		
10:00		7 Q		
		*411.00		
AVE.		*58.71		
-----				
17:00		3 Q		
		*40.00		
AVE.		*13.33		
18:00		1 Q		
		*6.10		
AVE.		*6.10		

\*: When you take Z1 report, “Z1” is printed.

# EJ REPORT READING AND RESETTING

The cash register provides an electronic journal (EJ) function. This function is intended to record the journal data in a memory instead of journal paper, and print the data as an EJ report. The register records the journal data in REG, , X/Flash, and Z/PGM modes. By default, a maximum of 3000 lines are stored in the memory. For details of EJ programming, please refer to "Other programming (Job code 68)" on page 58.

## ■ Printing journal data on the way of a transaction (temporary EJ printing)

You can print journal data of a current transaction recorded in EJ memory by pressing the  key during the transaction.

**NOTE** This function is valid when the receipt ON/OFF function is set to OFF. For changing the setting, refer to "Additional Information for BASIC SALES ENTRY" on page 29.

### • Sample report

```
22/10/12 12:22 000000#001071
1x 10.00          *10.00
DEPT. 07
1x 25.00          *25.00
DEPT. 08
```

## ■ Reading and resetting the electronic journal data (Issuing EJ report)

You can read the journal data stored in the EJ memory in the journal format by executing the following procedure in the X/Flash or Z/PGM mode.

To read all of the data: (X/Flash mode)

700 →  → 

To reset all of the data: (Z/PGM mode)

700 →  → 

To read the last 10 records: (X/Flash mode)

710 →  → 

- NOTE**
- By programming, you can also issue an EJ Z report without printing the journal data on it. Refer to "Other programming" (Job code 68) on page 58 for the programming.
  - To stop reading or resetting the data, press the  key. The data will not be erased when resetting.
  - On the EJ memory, a maximum of 3000 lines of data can be stored. When executing all data reading, all of the data stored in the EJ memory will be printed.

### • Sample EJ report

```
*X1*
E. JOURNAL
22/10/12 12:37 000000#001101
1x 6.20          *6.20
DEPT. 01
ITEMS 1q
CASH              *6.20
22/10/12 12:37 000000#001102
1x 4.50          *4.50
```

```
22/10/12 12:37 000000#001103
*X1*
PLU
22/10/12 12:37 000000#001104
SYSTEM PRESET *PGM*
22/10/12 12:38 000000#001105
1x 1.40          *1.40
DEPT. 01
1x 2.53          *2.53
DEPT. 01
1x 0.16          *0.16
DEPT. 01
ITEMS 3q
CASH              *4.09
22/10/12 12:38 000000#001106
1x 3.50          *3.50
```

} Header information print

```
DEPT. 01
ITEMS 1q
CASH              *4.72
22/10/12 12:38 000000#001110
1x 1.52          *1.52
DEPT. 01
1x 2.21          *2.21
DEPT. 01
1x 3.51          *3.51
DEPT. 01
ITEMS 3q
CASH              *7.24
* E J I END *
```



# EURO MIGRATION FUNCTION

**NOTE** EURO programming described in this section are for users in the countries which will join to the members of the European Currency Union, not for the users in the countries already have joined the Union.

Your register can be modified to correspond with each period set for the introduction of EURO, and in your register each currency is treated as shown on the table below depending on which period you are in. Basically your register can be automatically modified to correspond to the introduction of EURO by executing automatic EURO modification operation shown below in the Z/PGM mode. However, there are several options you must set depending on your needs. So, please carefully conduct necessary settings.

## How currencies are treated in your register

	Period 1	Period 2	Period 3
	After the introduction of EURO, and before EURO banknotes and coins begin to circulate	After EURO banknotes and coins begin to circulate, and before national currency is withdrawn from circulation. (Co-existence of EURO and national currency)	After the national currency is withdrawn from circulation
Currency	EURO	Exchange key	Domestic currency
	National currency	Domestic currency	Exchange key
	Foreign currency		Exchange key

## Automatic EURO modification operation

Make sure the mode switch is in the Z/PGM mode first, then perform the following procedure. Please note that you can perform each operation only once with the substitution of "A=1", "A=2" and "A=3". For example if you performed the operation with the substitution of "A=2" first, you cannot perform the operation with the substitution of "A=1".

800 → /RCPTSW → \*A → /AT/NS

- \* A=1: Applicable for period 1
- \* A=2: Applicable for period 2
- \* A=3: Applicable for period 3

The details of the register system modification are as shown below:

Items	A=1 (EURO status 1)	A=2 (EURO status 2)	A=3 (EURO status 3)
General Z1 report	Issue	Issue	Issue
General Z2 report	Issue	Issue	Issue
GT memories (GT1, GT2 and GT3)	-	Clear	Clear*1
Conversion of preset prices of Dept./ PLU	-	Yes	Yes*1
Exchange amount printing for total and change	Yes	Yes	No
Exchange calculation method	Division	Multiplication	Multiplication
Domestic currency symbol	-	[EURO]	[EURO]
Domestic currency decimal point position	-	2	2
Exchange currency symbol	[EURO]	Previous domestic currency symbol	-*2
Exchange currency decimal point position	2	Previous domestic currency - decimal point position	
Smallest coin (for rounding system)	-	Normal	Normal*1
Rounding up/down of the unit digits of amount	-	00	00*1
Limit of the least significant digit in entering amount of item	-	Arbitrary	Arbitrary*1
Limit of the least significant digit in entering amount of payment	-	Arbitrary	Arbitrary*1
Memory of difference due to rounding	-	No	No*1
Rounding of foreign currency for <input type="checkbox"/> EX	Round off (4 down/5 up)	Round off	Round off

• The item marked with “-” remains the same as the previous data.

\*1: When you perform from EURO status 2, previous data remains unchanged.

\*2: When you perform from EURO status 1 or 2, “space” is set.

## IMPORTANT

- Conversion of the preset unit prices of departments and PLUs  
Note that the conversion rate of the preset rate of the  EX key is applied for the conversion, and the method is set to “division”. When the conversion is performed, the message “PRICE CONVERTED” will be printed on the #800 report.
- After the execution of the procedure with “A=1”, treat EURO as foreign currency using the exchange key  EX with the preset rate entry. Set the EURO conversion rate as the currency exchange rate for the exchange key.
- After the execution of the procedure with “A=2”, treat EURO as domestic currency, and national currency as foreign currency using the exchange key  EX with the preset rate entry. Set the EURO conversion rate as the currency exchange rate for the exchange key.

**NOTE** You can manually make these settings. For programming details, please refer to programming section.

### Checking the current EURO status

You can check the EURO status currently set on the cash register. Turn the mode switch to the X/Flash position, and perform the following sequence. The current EURO status will be printed on the receipt.



## ■ Optional Programming for the Introduction of EURO

Some programming relating with the function of exchange key (EX) cannot be changed automatically with the execution of modification operation described in the previous section. After the execution on each period, conduct the following programming depending on your needs.

### Programming for Exchange Key (EX)

#### Currency exchange rate

For period 1 and period 2, set the EURO conversion rate.

For programming details, refer to “Rate for % and EX” on page 45.

#### Exchange rate entry selection

When you treat EURO currency in the exchange key, you can use the EX key function. For programming details, refer to “Function parameters for EX” on page 47.

#### Cheque/credit operation

For period 1 and period 2, enable cheque/credit operation when tendering in foreign currency so that you can treat cheque and credit for EURO currency and national currency. For programming details, refer to “EURO system settings” on page 63.

### Setting the date and time when the automatic modification operation for EURO should be executed Selection of compulsory/non-compulsory of execution of the automatic modification operation for EURO

You can program the scheduled date and time to execute the automatic EURO modification operation (for programming details, refer to page 64-65).

From ten days before the preset date, the remaining days are printed at the bottom of the daily full resetting (Z1) report as follows.

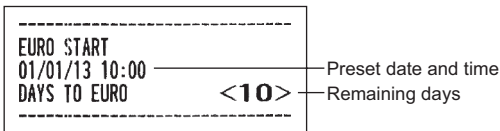

When the above-mentioned preset date and time has come, and also when you start an entry in the REG mode, the error symbol “E - E” is displayed. You cannot make any operation in the REG mode until you execute the automatic modification operation for EURO (job #800) in the Z/PGM mode.

You can program so that you can make entries in the REG mode even when the error symbol is displayed. Date and time setting will be reset after the execution of the automatic modification operation and you can program again the date and time for the next automatic modification operation.

# SD CARD FUNCTION

The register's data can be saved to the SD memory card, and the programming data can be loaded from the SD memory card.

To use the SD card function, turn the mode switch to the Z/PGM position and perform the corresponding operations.

## ■ Inserting and removing an SD memory card

The SD card slot is located on the right side of your register.

### Inserting an SD memory card

Insert an SD memory card into the SD card slot with the printed SD logo facing upwards. Push the card in steady with a finger until it clicks and release it slowly.

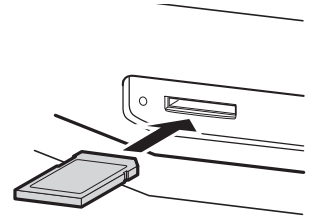

### Removing the SD memory card

Push in the card gently with a finger and release it. The card will come out.

- NOTE**
- This model supports SD cards only. Use of any other types of SD cards such as mini SD, micro SD, etc. with an adapter is not supported.
  - When inserting or removing the SD memory card, be sure to release it slowly. Otherwise, the card may pop out and injure your finger.
  - Never touch or remove the SD memory card while it is accessed, otherwise the data stored in it may be damaged.
  - Formatting the SD memory card erases all the data in it.

**Caution:** Never turn the power off, while the SD memory card is accessed.

## ■ SD card formatting

When the SD card is not formatted yet, take the formatting operation.

### Procedure

#/TM/ST → 140 → ⊗/RCPTSW → #/TM/ST → TL/AT/NS

The master folder "SHARP/ECRXXX14" is created for the data file.

## ■ Data saving

The sales data, EJ data or programming data can be saved to the SD card.

### Procedure



*Job no.	Saving data
141	All programming data
144	All RAM data
650	Sales data
750	EJ data (save and clear)

## ■ Data loading

The sales data, EJ data or programming data can be saved to the SD card.

### Procedure



*Job no.	Loading data
147	All programming data
148	All RAM data

**NOTE** The loading operation must be circumspect in execution, the data (#147: for all programming data, #148: for the sales data and all programming data) will be recovered with the back-up data.

## ■ Error message table of the SD card function

Error code	Error state and action
01	No SD memory card is found. Insert an SD memory card into the SD card slot or reinsert it correctly.
02	The write-protect switch on the SD memory card is in the "PROTECTED" position. Set the switch on the "NOT PROTECTED" position.
03	The SD memory card is full. Delete unnecessary data from the card on a PC or replace the card with a new one. When using a new SD memory card, be sure to format it in advance.
05	The data stored in the SD memory card is incorrect. Write correct data into the SD memory card on a PC.
09	The user folder is not found. (SHARP/ECRXXX14/user folder name)
10	Over limitation of data records (Over max. record in sales or EJ data.)
99	An error other than the above mentioned has occurred while the SD memory card is accessed. Perform the interrupted operation again from the beginning.

# OPERATOR MAINTENANCE

## 1 In Case of Power Failure

When power is lost, the machine retains its memory contents and all information on sales entries.  
(Note: Three alkaline batteries must be installed.)

- When power failure is encountered in register idle state or during an entry, the machine returns to normal operation after power recovery.
- When power failure is encountered during a printing cycle, the register prints “=====” and then carries out the correct printing procedure after power recovery. (See the sample print.)

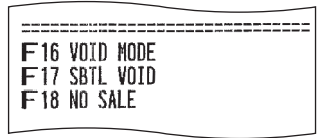

## 2 In Case of Printer Error

If the printer runs out of paper, the printer will stall, and “PPPPPPPPPP” will appear on the display. Key entries will not be accepted. Refer to section 5 in this chapter, install a new roll, then press the  key. The printer will print the power failure symbol and resume printing.

## 3 Cautions in Handling the Printer and Recording Paper

### ■ Cautions in handling the printer

- Avoid dusty and humid environments, direct sunlight and iron powder. (A permanent magnet and electromagnet are used in this machine.)
- Never pull the paper when the print roller arm is locked. First lift up the arm, and then remove the paper.
- Never touch the surface of the printer head and print roller.

### ■ Cautions in handling the recording paper (thermal paper)

- Use only the paper specified by SHARP.
- Do not unpack the thermal paper until you are ready to use it.
- Avoid heat. The paper will color at around 70°C.
- Avoid dusty and humid storage places. Avoid direct sunlight.
- The printed text on the paper can discolor under conditions of high humidity and temperature, exposure to the direct sunlight, contact with glue, thinner or a freshly copied blueprint, and heat caused by friction from scratching or other such means.
- Be very careful when handling the thermal paper. If you want to keep a permanent record, copy the printed text with a photocopier.

## 4 Replacing the Batteries

This cash register displays a low battery symbol (  $\text{L}$  ) when the batteries are low, and displays a no battery symbol (  $\text{L}$  ) when batteries are extremely low or batteries are not installed.

When the low battery symbol is displayed, replace the batteries with new ones as soon as possible. The existing batteries will be dead in about two days.

When the no battery symbol is displayed, replace the batteries immediately. Otherwise, if the AC adapter plug is disconnected or a power failure occurs, all the programmed settings will be reset to the default settings and any data stored in memory will be cleared.

**Caution:** While the no battery symbol is being displayed, do not turn the mode switch to any positions. Follow the battery replacement procedure below without changing the mode switch position. Never pull out the AC adapter from the AC outlet, all the programmed settings will be reset to the default settings and any data stored in memory will be cleared.

**NOTE** Be sure to observe precautions shown on page 1 when handling batteries.

### To replace the batteries:

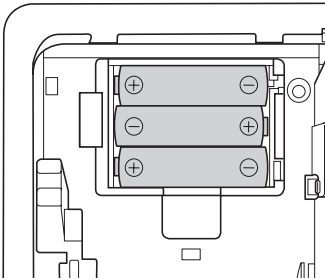

1. Make sure that the cash register is plugged in.
2. Remove the printer cover.
3. Open the battery compartment cover next to the paper roll cradle and remove the old batteries.
4. Install three new alkaline batteries LR6 (“AA” size) in the battery compartment. Be sure the positive and negative poles of each battery are facing in the proper direction. When they are installed correctly, the “ $\text{L}$ ” or “ $\text{L}$ ” symbol will disappear.
5. Close the battery compartment cover.
6. Replace the printer cover.

## 5 Replacing the Paper Roll

Be sure to use paper rolls specified by SHARP.

The use of any other paper rolls other than those specified could cause paper jamming, resulting in register malfunction.

### Paper specification

Paper width: 57.5 ± 0.5 mm

Max. outside diameter: 80 mm

Quality: High quality (0.06 to 0.08 mm thickness)

• **Be sure to set the paper roll prior to using your machine, otherwise it may cause a malfunction.**

Install the paper roll in the printer. Be careful to set the roll correctly.

### (How to set the paper roll)



## ■ Removing the paper roll

When a red dye appears on the paper roll, it is time to replace it. Replace the paper roll with a new one. If you plan on not using the register for an extended period of time, remove the paper roll, and store it in an appropriate place.

**Caution:** The paper cutter is mounted on the printer cover. Be careful not to cut yourself.

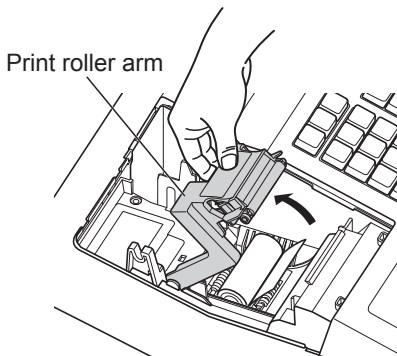

1. Remove the printer cover.
2. Lift up the print roller arm.
3. Remove the paper roll from the paper roll cradle.

**NOTE** Do not pull the paper through the printer.

## ■ Installing the paper roll

For information on how to install paper rolls, refer to “Installing a Paper Roll” on page 9.

**Caution:** The paper cutter is mounted on the printer cover. Be careful not to cut yourself.



## 6 Removing a Paper Jam

**Caution:** The paper cutter is mounted on the printer cover. Be careful not to cut yourself. Never touch the printer head immediately after printing, as the head may still be hot.

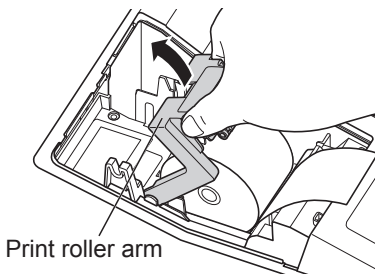

1. Remove the printer cover.
2. Lift up the print roller arm. (When a large roll paper is set, hold the both side of the print roller arm as per the diagram.)
3. Remove the paper jam. Check for and remove any shreds of paper that may remain in the printer.
4. Reset the paper roll correctly by following the steps in “Installing a Paper Roll” on page 9.

## 7 Cleaning the Printer (Printer Head / Sensor / Roller)

When the printed text is getting dark or faint, paper dust may be stuck to the printer head, sensor and/or roller. Clean them as follows:

**Caution:**

- Never touch the printer head with a tool or anything hard as it may damage the head.
- The paper cutter is mounted on the printer cover. Be careful not to cut yourself.

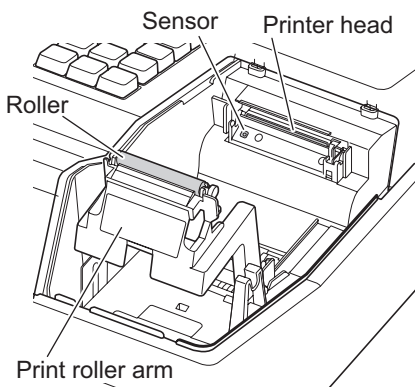

1. Turn the mode switch to the “⏻” position.
2. Remove the printer cover.
3. Lift up the print roller arm.
4. Remove the paper roll referring to the “Removing the paper roll” section.
5. Clean the printer head with a cotton swab or soft rag moistened with ethyl alcohol or isopropyl alcohol. Clean the roller and the sensor in the same manner.
6. Reset the paper roll correctly by following the steps in “Installing a Paper Roll” on page 9.

## 8 Removing the Drawer

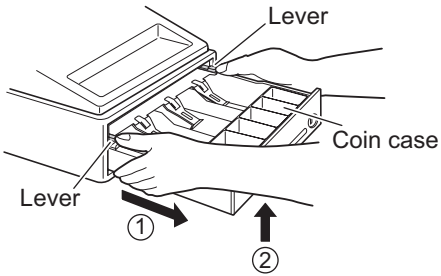

The drawer in the register is detachable. After closing your business for the day, remove the drawer. To detach the drawer, pull it forward fully, and while holding the lever down, lift the drawer slightly and remove. The 6-denomination coin case is detachable.

## 9 Opening the Drawer by Hand

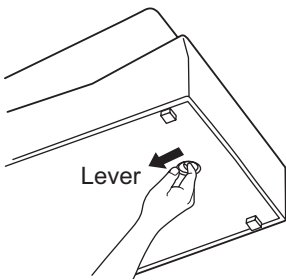

The drawer automatically opens. However, when a power failure occurs or the machine becomes out of order, slide the lever located on the bottom of the machine in the direction of the arrow. (See the diagram at the left.)

The drawer will not open if it is locked with the key.



# BEFORE CALLING FOR SERVICE

The malfunctions shown in the left-hand column below, labeled “Fault”, do not necessarily indicate functional faults of the machine. It is therefore advisable to refer to “Checking” shown in the right-hand column before calling for service.

Fault	Checking
(1) The display shows symbols that do not make sense.	<ul style="list-style-type: none"> <li>• Has the machine been initialized properly as shown in “PREPARING THE CASH REGISTER”? (Note that initialization clears all the data and programmed settings stored in memory.)</li> </ul>
(2) The display won't illuminate even when the mode switch is turned to any other position than “  ”.	<ul style="list-style-type: none"> <li>• Is power supplied to the electrical outlet?</li> <li>• Is the AC adapter plug out or loosely connected to the AC outlet?</li> </ul>
(3) The display is illuminated, but the whole machine refuses registrations.	<ul style="list-style-type: none"> <li>• Is the mode switch set properly at the “REG” position?</li> </ul>
(4) No receipt is issued.	<ul style="list-style-type: none"> <li>• Is the paper roll properly installed?</li> <li>• Is there a paper jam?</li> <li>• Is the receipt function in the “OFF” status?</li> <li>• Is the print roller arm securely locked?</li> </ul>
(5) Printing is unusual.	<ul style="list-style-type: none"> <li>• Is the print roller arm securely locked? Open the print roller arm, and lock the arm by following the instruction of installation.</li> <li>• Is the paper roll properly installed?</li> <li>• Are the printer head/sensor/roller clean?</li> </ul>
(6) Continuous printing stops.	<ul style="list-style-type: none"> <li>• “-” will be displayed in order from left to right continuously. It occurs when the printer temperature is high. Printing will automatically restart after several seconds.</li> </ul>

## ■ Error code table

When the following error codes are displayed, press the  key and take a proper action according to the table below.

Error code	Error status	Action
E01	Registration error	Make a correct key entry.
E02	Misoperation error	Make a correct key entry.
E11	Compulsory depression of the  key	Press the  key and continue the operation.
E12	Compulsory tendering	Make a tendering operation.
E33	Compulsory SCM (starting cash memory) entry	Make the SCM (starting cash memory) entry.
E34	Overflow limitation error	Make a registration within a limit of entry.
E35	The open price entry is inhibited.	Make a preset price entry.
E36	The preset price entry is inhibited.	Make an open price entry.
E37	The direct finalization is inhibited.	Make a tendering operation.
E67	Subtotal void is not allowed.	Finalize the transaction, and correct the wrong entries in the  mode.
E80	The battery trouble is occurred.	Change the battery.

# SPECIFICATIONS

Model:	XE-A137 XE-A147	
Dimensions:	335 (W) x 360 (D) x 190 (H) mm	
Weight:	Approx. 5 kg	
Power Source:	Official (nominal) voltage and frequency	
Power Consumption:	Stand-by: 1.9 W (The official voltage: 220 to 230V [50Hz/60Hz] and 230 to 240 V [50 Hz]) Operating: 8.1 W (The official voltage: 220 to 230 V [50Hz/60Hz] and 230 to 240 V [50 Hz])	
Working Temperature:	0 to 40 °C (32 to 104 °F)	
Humidity:	20 % to 90 %	
Electronics:	LSI (CPU) etc.	
Display:	7-segment display (9 positions)	
Printer:	Type:	One-station thermal printer
	Printing speed:	Approx. 7 lines/second
	Printing capacity:	30 digits
	Other functions:	- Receipt (ON-OFF) function
Logo:	Graphic logo printing:	
	Size:	130 (H) x 360 (W) pixel Area of black must be less than 35% of all area.
	Logo message printing:	
	Logo message for the receipt (max. 30 characters x 6 lines)	
Paper Roll:	Width: 57.5 ± 0.5 mm Max. diameter: 80 mm Quality: High quality (0.06 to 0.08 mm thickness)	
Cash Drawer:	3 slots for bills and 6 for coin denominations	
Accessories:	Basic user manual:	1 copy
	Paper roll:	1
	Mode key (same as drawer lock key):	2
	AC adapter:	1
	Fiscal caution sheet:	1 (for Germany and Norway)

\*Specifications and appearance are subject to change without notice for improvement.

## ■ Option

The following sharp option is available only for your XE-A147 register.

- Option battery model XE-A1BT

For installing option battery XE-A1BT, please refer to "XE-A1BT Installation Manual".

**CAUTION:** (only for the XE-A147)

Shielded interface cables must be used with this equipment to maintain compliance with EMC regulations.

**XE-A137**

Noise level LpA: 56.4 dB(A-weighted)

Measured according to EN ISO 7779:2001

[Maximum value if the cash drawer springs open LpA: 71.4 dB(A-weighted)]

**XE-A147**

Noise level LpA: 53.0 dB(A-weighted)

Measured according to EN ISO 7779:2001

[Maximum value if the cash drawer springs open LpA: 70.1 dB(A-weighted)]

**SHARP®**

**SHARP ELECTRONICS (Europe) GmbH**

Postbox 105504

20038 Hamburg, Germany

**SHARP CORPORATION**