

TE-M80

Electronic Cash Register



TE-M80-S



TE-M80-M

User's Manual

START-UP is QUICK and EASY!
Simple to use!
15 departments
Automatic Tax Calculations
Calculator function

CASIO®



Thank you very much for purchasing this CASIO electronic cash register.
START-UP is QUICK and EASY!

Part-1 of this user's manual can help you make a quick start.

Once you have mastered the QUICK START operations, you will undoubtedly want to expand your use of this machine by studying other sections of Part-2.

Original carton / package

If for any reason, this product is to be returned to the store where purchased, it must be packed in the original carton/package.

Location

Locate the cash register on a flat, stable surface, away from heaters or areas exposed to direct sunlight, humidity or dust.

Power supply

Your cash register is designed to operate on standard household current (120V, 220V, 230V or 240V; 50/60Hz). Do not overload the outlet by plugging in too many appliances.

Cleaning

Clean the cash register exterior with a soft cloth which has been moistened with a solution of a mild neutral detergent and water, and wrung out.

Be sure that the cloth is thoroughly wrung out to avoid damage to the printer.

Never use paint thinner, benzene, or other volatile solvents.

Safety precautions

- To use this product safely and correctly, read this manual thoroughly and operate as instructed. After reading this guide, keep it close at hand for easy reference. Please keep all informations for future reference.
- Always observe the warnings and cautions indicated on the product.

About the icons

In this guide various icons are used to highlight safe operation of this product and to prevent injury to the operator and other personnel and also to prevent damage to property and this product. The icons and definitions are given below.



Indicates that there is a risk of severe injury or death if used incorrectly.



Indicates that injury or damage may result if used incorrectly.

Icon examples

To bring attention to risks and possible damage, the following types of icons are used.



The \triangle symbol indicates that it includes some symbol for attracting attention (including warning). In this triangle the actual type of precautions to be taken (electric shock, in this case) is indicated.



The \otimes symbol indicates a prohibited action. In this symbol the actual type of prohibited actions (disassembly, in this case) will be indicated.



The \bullet symbol indicates a restriction. In this symbol the type of actual restriction (removal of the power plug from an outlet, in this case) is indicated.

Warning!

Handling the register



Should the register malfunction, start to emit smoke or a strange odor, or otherwise behave abnormally, immediately shut down the power and unplug the AC plug from the power outlet. Continued use creates the danger of fire and electric shock.

- Contact CASIO service representative.



Do not place containers of liquids near the register and do not allow any foreign matter to get into it. Should water or other foreign matter get into the register, immediately shut down the power and unplug the AC plug from the power outlet. Continued use creates the danger of short circuit, fire and electric shock.

- Contact CASIO service representative.



Should you drop the register and damage it, immediately shut down the power and unplug the AC plug from the power outlet. Continued use creates the danger of short circuit, fire and electric shock.

- Attempting to repair the register yourself is extremely dangerous. Contact CASIO service representative.

 **Warning!**



Never try to take the register apart or modify it in any way. High-voltage components inside the register create the danger of fire and electric shock.

- Contact CASIO service representative for all repair and maintenance.

Power plug and AC outlet



Use only a proper AC electric outlet. Use of an outlet with a different voltage from the rating creates the danger of malfunction, fire, and electric shock. Overloading an electric outlet creates the danger of overheating and fire.



Make sure the power plug is inserted as far as it will go. Loose plugs create the danger of electric shock, overheating, and fire.

- Do not use the register if the plug is damaged. Never connect to a power outlet that is loose.



Use a dry cloth to periodically wipe off any dust built up on the prongs of the plug. Humidity can cause poor insulation and create the danger of electric shock and fire if dust stays on the prongs.



Do not allow the power cord or plug to become damaged, and never try to modify them in any way. Continued use of a damaged power cord can cause deterioration of the insulation, exposure of internal wiring, and short circuit, which creates the danger of electric shock and fire.

- Contact CASIO service representative whenever the power cord or plug requires repair or maintenance.

 **Caution!**



Do not place the register on an unstable or uneven surface. Doing so can cause the register — especially when the drawer is open — to fall, creating the danger of malfunction, fire, and electric shock.



Do not place the register in the following areas.

- Areas where the register will be subject to large amounts of humidity or dust, or directly exposed to hot or cold air.
- Areas exposed to direct sunlight, in a close motor vehicle, or any other area subject to very high temperatures.

The above conditions can cause malfunction, which creates the danger of fire.



Do not overlay bend the power cord, do not allow it to be caught between desks or other furniture, and never place heavy objects on top of the power cord. Doing so can cause short circuit or breaking of the power cord, creating the danger of fire and electric shock.



Be sure to grasp the plug when unplugging the power cord from the wall outlet. Pulling on the cord can damage it, break the wiring, or cause short, creating the danger of fire and electric shock.



Never touch the plug while your hands are wet. Doing so creates the danger of electric shock. Pulling on the cord can damage it, break the wiring, or cause short, creating the danger of fire and electric shock.

Never touch the printer head and the platen.

Contents

Getting to know your cash register	6
Daily Job Flow	8
Part-1 QUICK START OPERATION	9
(You can operate this ECR on a basic level by reading the following sections)	
1. Initialization	9
2. To select the language	9
3. To select date format and monetary mode	9
4. Loading paper	10
5. Basic programming for QUICK START – TIME/DATE	11
6. Basic operation after basic programming	13
7. Daily management report	17
Part-2 CONVENIENT OPERATION	19
(Please keep these sections to expand your use.)	
1. Various programming	19
2. Various operations	32
Part-3 CALCULATOR FUNCTION	36
1. Calculator mode	36
Part-4 USEFUL INFORMATION	38
1. Troubleshooting	38
2. Specifications	39

Before you start

Unpacking

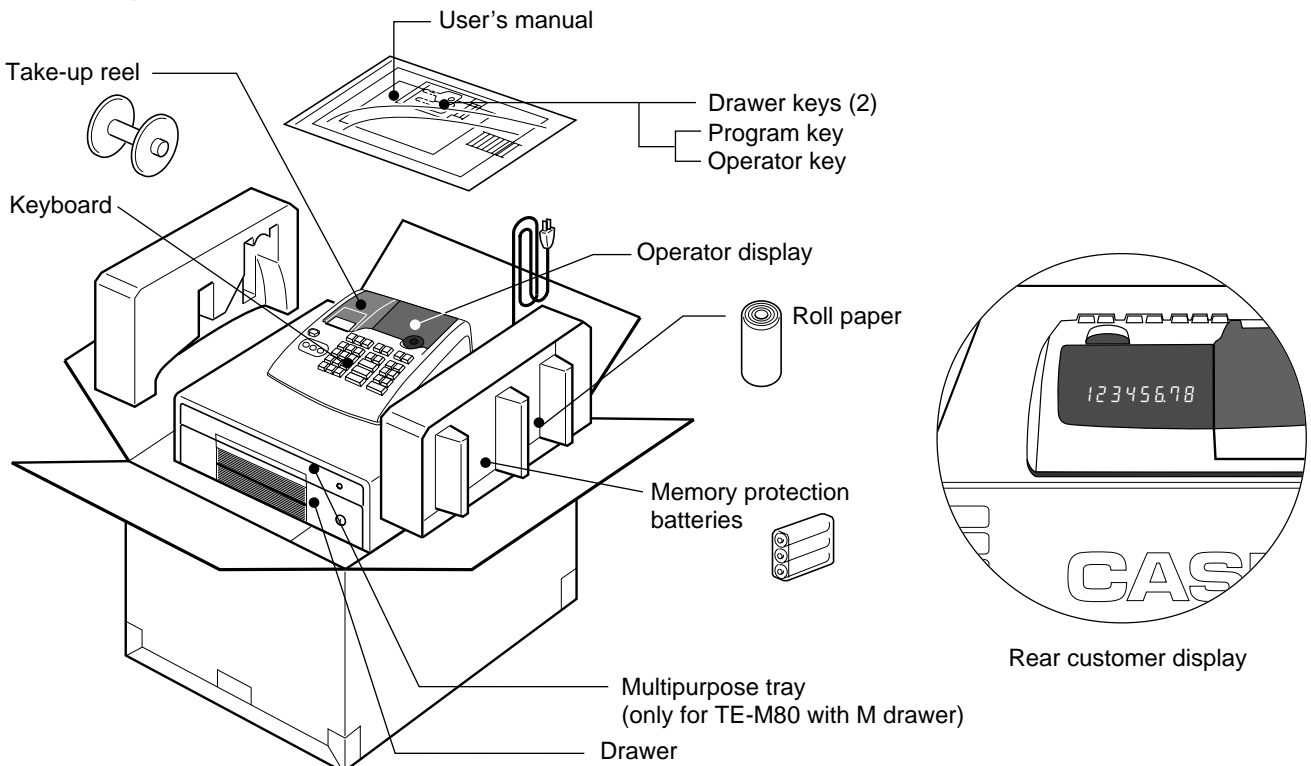

Getting to know your cash register

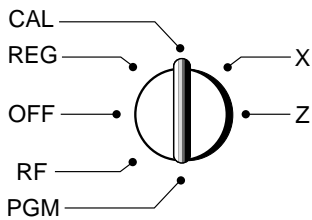

The position of the mode switch controls the type of operations you can perform on the cash register. The PROGRAM key (marked PGM) that comes with the cash register can be used to select any mode switch setting, while the OPERATOR key (marked OP) can be used to select OFF, REG or CAL only.

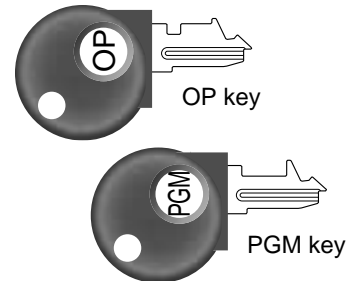
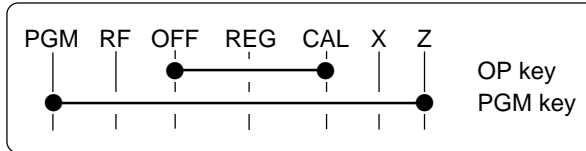

Note:

An error is generated (E01 displayed) whenever the position of the mode switch is changed during registration.

OFF

In this position, the power of the cash register is off.

REG (Register)

This is the position used for registration of normal transactions.

RF (Refund)

This is the position used for registration of refunds.

CAL (Calculator)

This is the position used for calculator mode.

PGM (Programming)

This is the position used to program the cash register to suit the needs of your store.

X (Read)

This is the position used to produce reports of daily sales totals without clearing the totals.

Z (Reset)

This is the position used to produce reports of daily sales totals. This setting clears the totals.

Displays

Operator display

Rear customer display

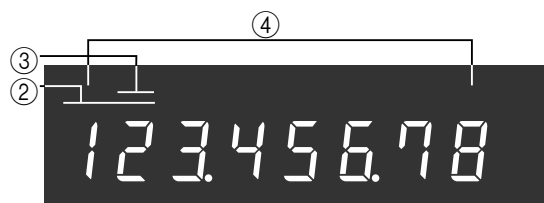
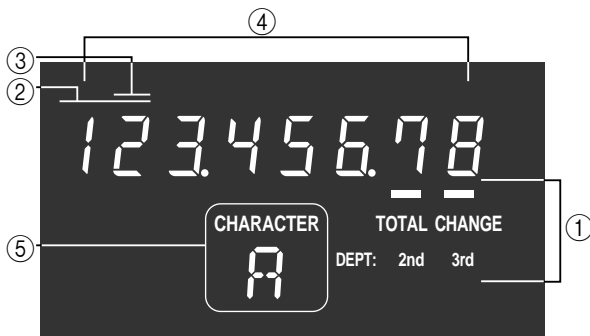

① **Total/Change indicator**

The total or change indicator appears when a subtotal, total or change is obtained. These indicators are also used for department shift level.

② **Department number display**

Anytime you press a department key to register a unit price, the corresponding department number appears here.

③ **Number of repeat display**

Anytime you perform "repeat registration" (page 13), the number of repeats appears here.

Note that only one digit is displayed for the number of repeats.

④ **Numeric display**

Entered values (unit prices or quantities) and calculated values (subtotals, totals or change amount due) are displayed here. The capacity of the display is 8 digits.

This part of the display can be used to show the current time or date between registration (page 34).

⑤ **Character display**

In the character programming (P2) mode, it shows the last entered character.

Keyboard



Certain keys have two functions; one for register mode and one for calculator mode.

In this manual, we will refer to specific keys as noted below to make the operations as easy to understand as possible:

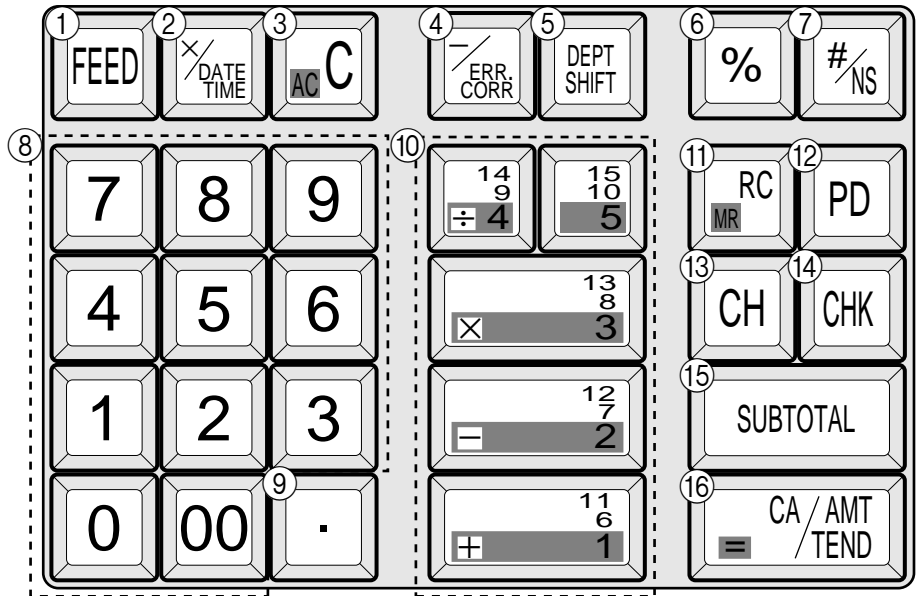

Register Mode

- ① **FEED** Feed key
- ② **X/DATE TIME** Multiplication / Date time key
- ③ **AC C** Clear key
- ④ **-/ERR CORR** Minus / Error correction key
- ⑤ **DEPT SHIFT** Department shift key
- ⑥ **%** Percent key
- ⑦ **#/NS** Reference number/No sale key
Drawer open key
- ⑧ **0 1 ~ 9, 00**
Numeric keys and 2-zero key
- ⑨ **.** Decimal key
- ⑩ **+1, -2, x3, ÷4, 5** Department keys
 - Department 6 through 15 are specified by pressing the **#/DEPT SHIFT** key (once or twice) respectively as follows:
 - #/DEPT SHIFT +1** → Department 6 **#/DEPT SHIFT -2** → Department 7...
 - #/DEPT SHIFT 5** → Department 10 ... **#/DEPT SHIFT +1** → Department 11
 - ... **#/DEPT SHIFT #/DEPT SHIFT 5** → Department 15
- ⑪ **RC/MR** Received on account key
- ⑫ **PD** Euro / Payout key
- ⑬ **CH** Charge key
- ⑭ **CHK** Check key
- ⑮ **SUB TOTAL** Subtotal key
- ⑯ **= CA/AMT TEND** Cash amount tendered key

- ⑰ Paper saving key

- Paper saving key is the key to save printing paper (Journal compressed printing / No receipt issuing).
In these cases, the LED of this key lights.

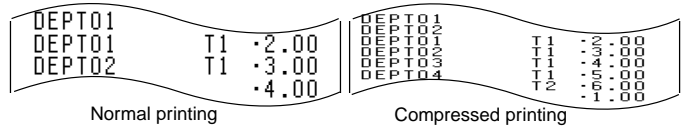

- ⑱ Post receipt key
- Post receipt key is used for issuing receipt after transaction. This key is effective if the printer is defined as printing receipts. Refer to page 33.

- ⑲ Help key
- Help key is used for issuing assistant receipts such as programming date/time, paper installation etc.

- ⑳ **OPEN** Printer open key
- Printer open key is used to open printer platen for setting/replacing roll paper.

Calculator Mode

- ③ **AC c** AC key
- ⑥ **%** Percent key
- ⑧ **0 1 ~ 9, 00** Numeric keys and 2-zero key
- ⑨ **.** Decimal key
- ⑩ **+1, -2, x3, ÷4** Arithmetic operation keys
- ⑪ **RC/MR** Memory recall key
- ⑯ **= CA/AMT TEND** Equal key

Daily Job Flow

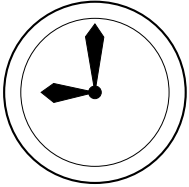

Before opening the store

1. Plugged in?
2. Enough roll paper?
3. Date and time is correct?
4. Enough small change in the drawer?

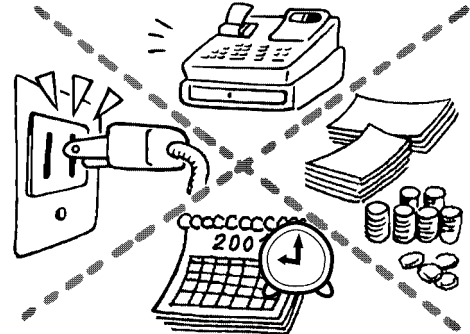

While the store is open

1. Registrations.
2. Issuing latest daily sales total if needed. (Generating report by mode switch to X position.)

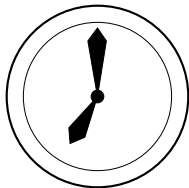

After closing the store

1. Issuing daily sales total. (Resetting report by mode switch to Z position.)
2. Picking up money in the drawer.
3. Turn the mode switch to OFF.

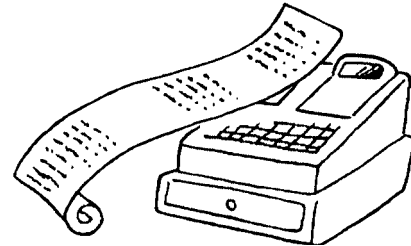

To lock/unlock the multipurpose tray

(only for TE-M80 with M drawer)

- A. Turn the lever (1) clockwise to lock the tray (the indicator becomes red).
- B. Turn the lever (1) counterclockwise to unlock the tray (the indicator becomes green).

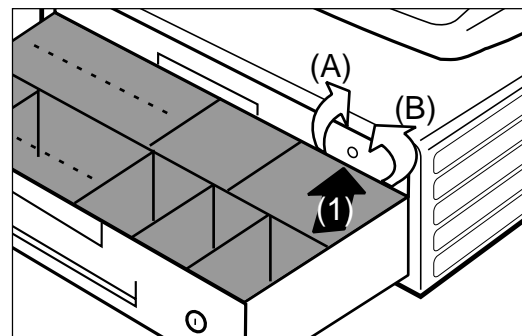

1. Initialization and loading memory protection battery

Important

You must initialize the cash register and install the memory protection batteries before you can program the cash register.

To initialize the cash register

1. Set the mode switch to OFF.
2. Plug the power cord of the cash register into an AC outlet.
3. Load the memory protection batteries.
4. Set the mode switch to REG.

To load the memory protection batteries

1. Remove the printer cover.
2. Press down on the oval just behind the printer paper inlet, and slide the battery compartment cover toward the back of the cash register.
3. Load 3 new UM-3, R6P (SUM-3) or LR6 (AM-3) type batteries into the compartment. Be sure that the plus (+) and minus (-) ends of each battery are facing in the directions indicated by the illustrations inside the battery compartment (Figure 1).
4. Slide the memory protection battery compartment cover back into place.
5. Replace the printer paper and printer cover.



(Figure 1)

REPLACE MEMORY PROTECTION BATTERIES AT LEAST ONCE EVERY YEAR.

2. To select the language

You can select the default printing language depending on the requirements in your area.

Example: Change the language to Spanish.

1. Set the mode switch to PGM.
2. Press the following keys.

2 9 9 9 ● Select numbers from list A.

Language selections					
A	English	1	9	9	9
	Spanish	2	9	9	9
	French	3	9	9	9
	German	4	9	9	9

3. To select date format and monetary mode

You can select the date format and the monetary mode.

Example: Change the date format to Month/Day/Year, and the monetary mode to Add 0.

1. Set the mode switch to PGM.
2. Press the following keys.

0 1 2 2 **3** **SUB TOTAL** P3 appears in mode display
1 0 **SUB TOTAL** Program set code number
= **CA/AMT** Select numbers from lists B and C.
SUB TOTAL (To end the setting)

Date format selections		
B	Year/Month/Day	0
	Month/Day/Year	1
	Day/Month/Year	2

Monetary mode selections		
C	Add 0 (0.)	0
	Add 1 (0.0)	1
	Add 2 (0.00)	2

4. Loading paper roll

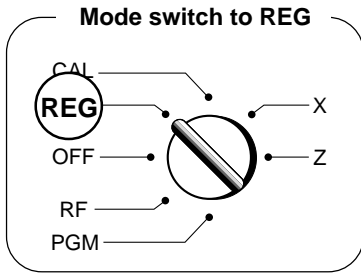

1. To load journal paper

- ① Pressing down the printer open key.



- ② Open the platen arm.



- ③ Ensuring the paper is being fed from the bottom of the roll, lower the roll into the space behind the printer.



- ④ Put the leading end of the paper over the printer.



- ⑤ Close the platen arm slowly until it locks steadily.



- ⑥ Remove the printer cover by lifting up the back.

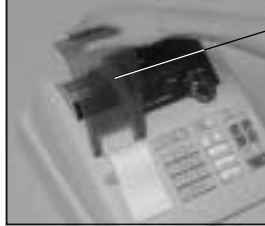

- ⑦ Roll the paper onto the take-up reel a few turns.



- ⑧ Set the left plate of the take-up reel and place the reel into the register.



- ⑨ Press the **FEED** key to take up any slack in the paper.

- ⑩ Replace the printer cover slowly.



2. To remove journal paper

- ① Remove the printer cover by lifting up the back.



- ② Press the **FEED** key until approximately 20cm of the paper is fed from the printer.

- ③ Cut off the roll paper.



- ④ Remove the take-up reel from the printer and take off the left plate of the reel.

- ⑤ Remove the journal paper from the take-up reel.



- ⑥ Press the printer open key and open the platen arm.



- ⑦ Remove the core of the paper.



- ⑧ Load new paper following the instructions "1. To load journal paper".

Default printer definition is journal printer. To print receipts, please refer to 1-7-3 on page 24 to switch the printer for receipt or journal.

▶ To load receipt paper

- ① In case of defining the printer as receipt printer, follow steps 1 through 5 of "To load journal paper".

- ② Pass the leading end of the receipt paper through the paper outlet of the printer cover.

- ③ Tear off any excess paper.

▶ To remove receipt paper

- ① In case of defining the printer as journal printer, follow steps 6 through 7 of "To remove a journal paper".

▶ Caution (in handling the thermal paper)

1. Never touch the printer head and platen.
2. Unpack the paper just before your use.
3. Avoid heat/direct sunlight.
4. Avoid dusty and humid places for storage.
5. Do not scratch the paper.
6. Do not keep the paper under the following circumstances: High humidity and temperature/direct sunlight/contact with glue, thinner or a rubber eraser.

5. Basic programming for QUICK START

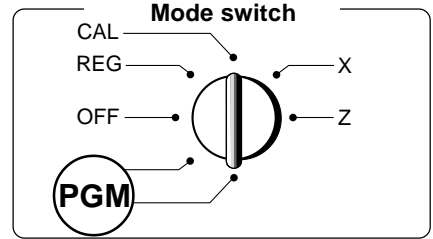

Part-1

Procedure	Purpose
<p>1. Insert the PROGRAM key (marked "PGM") and rotate to PGM position.</p>	<p>Programming</p>
<p>2. Press the following keys to set the current time.</p> <p>Example: 13:18 PM = 1318</p> <div style="display: flex; align-items: center; justify-content: center;"> <div style="text-align: center; margin-right: 10px;"> <p>1 3 1 8</p> <p>Time Minutes</p> </div> <div style="margin-right: 10px;"> <p>1 SUB TOTAL</p> </div> <div style="margin-right: 10px;"> <p>X/DATE TIME</p> </div> <div> <p>AC C</p> </div> </div> <p>P appears in mode display (to end the time setting)</p> <ul style="list-style-type: none"> • Enter 4 digits • 24-hour time format 	<p>Setting the current time</p>
<p>3. Press the following keys to set the current date.</p> <p>Example: January 8, 2004 = 040108</p> <div style="display: flex; align-items: center; justify-content: center;"> <div style="text-align: center; margin-right: 10px;"> <p>0 4 0 1 0 8</p> <p>Year Month Day</p> </div> <div style="margin-right: 10px;"> <p>1 SUB TOTAL</p> </div> <div style="margin-right: 10px;"> <p>X/DATE TIME</p> </div> <div> <p>AC C</p> </div> </div> <p>P appears in mode display (to end the date setting)</p> <ul style="list-style-type: none"> • Enter 6 digits • Enter last 2 digits for year set. (2004 → 04) 	<p>Setting the current date</p>
<p>4. You can set only one tax calculation system – either an add-on or an add-in depending on the laws in your area. Press the following keys to set the tax rate.</p> <p>Example: Set tax rate 1 as 5.25% and tax rate 2 as 10%.</p> <div style="display: flex; align-items: center; justify-content: center; margin-bottom: 10px;"> <div style="text-align: center; margin-right: 10px;"> <p>3 SUB TOTAL</p> </div> <div> <p>P3 appears in mode display</p> </div> </div> <div style="display: flex; align-items: center; justify-content: center; margin-bottom: 10px;"> <div style="text-align: center; margin-right: 10px;"> <p>0 1 2 5</p> </div> <div style="margin-right: 10px;"> <p>SUB TOTAL</p> </div> <div> <p>Program set code No. for tax rate 1</p> </div> </div> <div style="display: flex; align-items: center; justify-content: center; margin-bottom: 10px;"> <div style="text-align: center; margin-right: 10px;"> <p>5 . 2 5</p> </div> <div style="margin-right: 10px;"> <p>= CA/AMT TEND</p> </div> <div> <p>5.25% tax rate</p> </div> </div> <div style="display: flex; align-items: center; justify-content: center; margin-bottom: 10px;"> <div style="text-align: center; margin-right: 10px;"> <p>5 0 0 3</p> </div> <div style="margin-right: 10px;"> <p>= CA/AMT TEND</p> </div> <div> <p>50 for Round off and 03 for VAT (Value Added Tax) – Add In</p> </div> </div> <div style="display: flex; align-items: center; justify-content: center; margin-bottom: 10px;"> <div style="text-align: center; margin-right: 10px;"> <p>SUB TOTAL</p> </div> <div> <p>Program set code No. for tax rate 2</p> </div> </div> <div style="display: flex; align-items: center; justify-content: center; margin-bottom: 10px;"> <div style="text-align: center; margin-right: 10px;"> <p>0 2 2 5</p> </div> <div style="margin-right: 10px;"> <p>SUB TOTAL</p> </div> <div> <p>Program set code No. for tax rate 2</p> </div> </div> <div style="display: flex; align-items: center; justify-content: center; margin-bottom: 10px;"> <div style="text-align: center; margin-right: 10px;"> <p>1 0</p> </div> <div style="margin-right: 10px;"> <p>= CA/AMT TEND</p> </div> <div> <p>10% tax rate</p> </div> </div> <div style="display: flex; align-items: center; justify-content: center; margin-bottom: 10px;"> <div style="text-align: center; margin-right: 10px;"> <p>5 0 0 3</p> </div> <div style="margin-right: 10px;"> <p>= CA/AMT TEND</p> </div> <div> <p>50 for Round off and 03 for VAT (Value Added Tax) – Add In</p> </div> </div> <div style="display: flex; align-items: center; justify-content: center;"> <div style="text-align: center; margin-right: 10px;"> <p>SUB TOTAL</p> </div> <div> <p>(to end the setting)</p> </div> </div> <ul style="list-style-type: none"> • See page 25 to specify the tax system and rounding for details. 	<p>Setting the tax rate</p>
<p>5. Press the following keys to preset tax status of departments.</p> <p>Tax status for the departments are fixed as nontaxable.</p> <p>Example: Set departments 1 and 2 as taxable status 1.</p> <div style="display: flex; align-items: center; justify-content: center; margin-bottom: 10px;"> <div style="text-align: center; margin-right: 10px;"> <p>1 SUB TOTAL</p> </div> <div> <p>P appears in mode display</p> </div> </div> <div style="display: flex; align-items: center; justify-content: center; margin-bottom: 10px;"> <div style="text-align: center; margin-right: 10px;"> <p>RC/MR + 1</p> </div> <div style="margin-right: 10px;"> <p>SUB TOTAL</p> </div> <div style="text-align: center; margin-right: 10px;"> <p>1 2</p> </div> <div style="margin-right: 10px;"> <p>- 2</p> </div> <div> <p>SUB TOTAL</p> </div> </div> <ul style="list-style-type: none"> • See page 19 to change the fixed tax status. 	<p>Setting the status of departments</p>

Procedure	Purpose
<p>6. For the Euro only</p> <p>6-1. Press the following keys to define the main currency/print out currency of the subtotal.</p> <div style="text-align: center;"> <p>3 SUB TOTAL P3 appears in mode display</p> <p>2 4 2 2 SUB TOTAL</p> <p>1 CA / AMT = / TEND</p> <p>Euro status</p> <p>SUB TOTAL (to end the setting)</p> <p>Euro status</p> <p>(1) Main currency = Local, Print out subtotal = Local: 0</p> <p>(2) Main currency = Euro, Print out subtotal = Euro: 1</p> <p>(3) Main currency = Local, Print out subtotal = Both: 2</p> <p>(4) Main currency = Euro, Print out subtotal = Both: 3</p> </div> <p>6-2. Press the following keys to set the currency exchange rate against the Euro.</p> <div style="text-align: center;"> <p>3 SUB TOTAL P3 appears in mode display</p> <p>1 9 9 9 SUB TOTAL</p> <p>1 9 7 7 3 CA / AMT = / TEND</p> <p>Exchange rate (up to 6 digits) Decimal position</p> <p>SUB TOTAL (to end the setting)</p> <p>Example: (Exchange rate and decimal position)</p> <p>Currency exchange rate = 1 Euro in local currency</p> <p>1 Euro = 1.95583 DM : 1 9 5 5 8 3 5</p> </div>	<p>Setting the Euro</p>

Procedure	Purpose
<p>For Australia only.</p> <p>You can set some programmable options to suit the Australian GST by the following procedure.</p> <p>1. Insert the PROGRAM key (marked "PGM") and rotate to Z position.</p> <p>2. Press the following keys to program.</p> <div style="text-align: center;"> <p>0 1 0 1 2 0 0 1 SUB TOTAL CA / AMT = / TEND</p> <p>If you want to cancel this operation, press SUB TOTAL instead of CA / AMT = / TEND.</p> </div>	<p>Setting the Australian GST</p>

Procedure	Purpose
<p>For the Euro only.</p> <p>You can restrict the registerable currency to the Euro only by the following procedure.</p> <p>1. Insert the PROGRAM key (marked "PGM") and rotate to Z position.</p> <p>2. Issue all reset report including periodic data.</p> <p>3. Press the following keys to set.</p> <div style="text-align: center;"> <p>0 1 0 7 2 0 0 2 SUB TOTAL CA / AMT = / TEND</p> <p>If you want to cancel this operation, press SUB TOTAL instead of CA / AMT = / TEND.</p> </div>	<p>Restricting the currency (Euro)</p>

6. Basic operation after basic programming

Note:

Whenever an error is generated (E01 displayed), the input figures reset to 0.

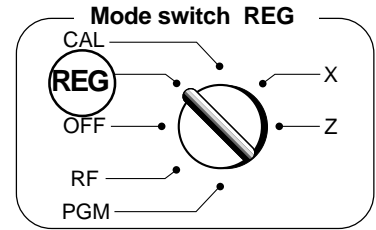

Part-1



6-1 Open the drawer without a sale



6-2 Basic operation

Example

Unit Price	\$1.00	\$2.00
Quantity	1	1
Dept.	1	10
Cash Amount tendered	\$5.00	

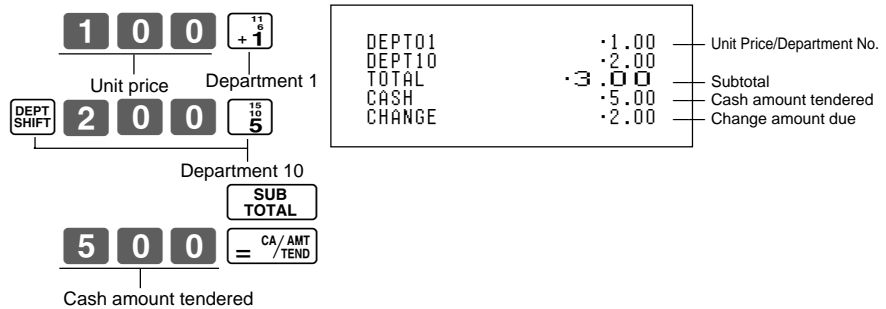

Departments 6 through 10 and 11 through 15 can also be registered in combination with the DEPT SHIFT and $\frac{1}{1}$, $\frac{2}{2}$, $\frac{3}{3}$, $\frac{4}{4}$ or $\frac{5}{5}$ keys, respectively. The DEPT SHIFT key should be entered once for department 6 ~ 10, twice for department 11 ~ 15 just before entering unit price manually.

6-3 Multiple registration of the same items

Example

Unit Price	\$1.00	\$1.35
Quantity	2	3
Dept.	1	2

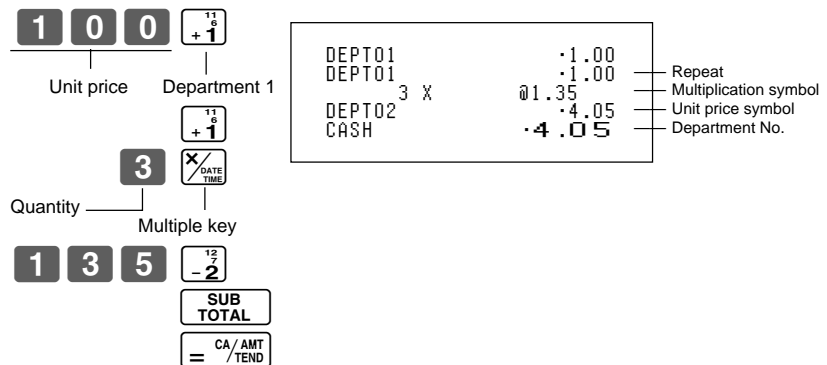

Note that repeat registration can be used with unit prices up to 6 digits long.

6-4 Charge sales

Example

Unit Price	\$1.00	\$2.00	\$3.00
Quantity	1	1	1
Dept.	1	2	1

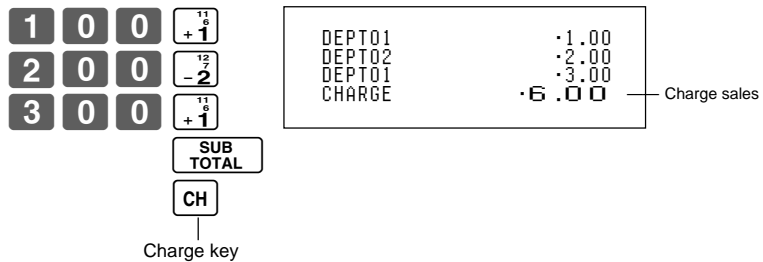

You cannot perform the amount tendered operation using the CH key.

6-5 Split cash/charge sales

Example

Unit Price	\$2.00	\$3.00	\$4.00
Quantity	1	1	1
Dept.	1	2	1
Cash Amount tendered	\$5.00		

Operation

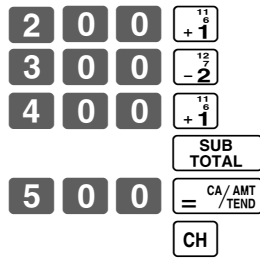

Printout

DEPT01	.2.00	
DEPT02	.3.00	
DEPT01	.4.00	
TOTAL	.9.00	
CASH	.5.00	Cash amount tendered
CHARGE	.4.00	Charge sales

6-6 Corrections

Corrections can be made while you are registering the item (before you press a department key), or after it has already been registered into the memory (by pressing a department key).

6-6-1 Before you press a department key

AC C key clears the last item entered.

Example

- Entered 400 for unit price by mistake instead of 100.

Operation

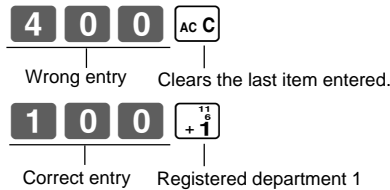

Printout

DEPT01	.1.00
--------	-------

- Entered unit price first instead of quantity and then pressed $\overset{X}{\text{FOR DATE TIME}}$.

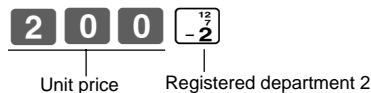
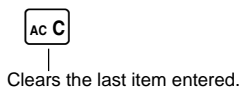

DEPT02	5 X @2.00	.10.00
--------	-----------	--------

- Entered 150 for unit price by mistake instead of 105.

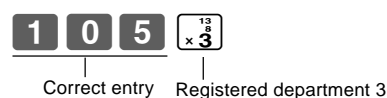
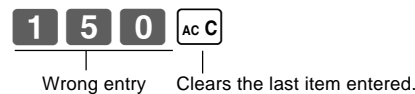
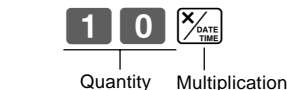

DEPT03	10 X @1.05	.10.50
--------	------------	--------

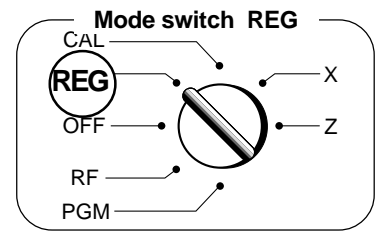

Operation

Printout

6-6-2 After you pressed a department key

key cancels the last registered item.

Example

- Entered unit price 550 by mistake instead of 505 and pressed a department key.

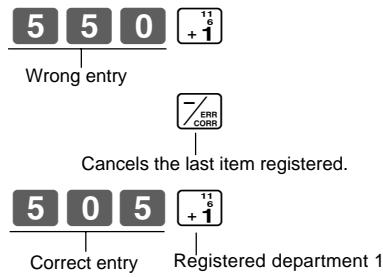

DEPT01	•5.50
ERR CORR	-5.50
DEPT01	•5.05

- Entered unit price 220 by mistake instead of 230 and pressed a department key.

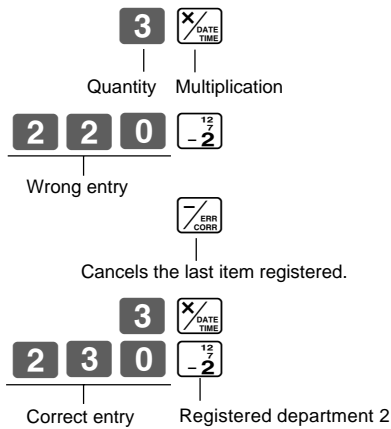

DEPT02	3 X	@2.20
ERR CORR		-6.60
DEPT02	3 X	@2.30
		-6.90

6-7 Currency exchange

6-7-1 Registering with currency exchange

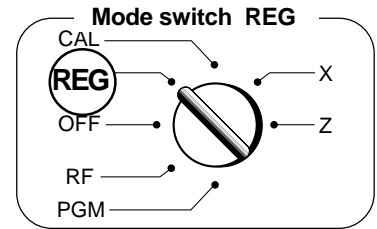

Example

Unit Price	2.00
Quantity	3
Dept.	1
Cash Amount Tendered	Euro 15.00
Rate	1Euro = 0.5 Fr
Main currency	Local (Fr)
Printout of ST	Both currencies

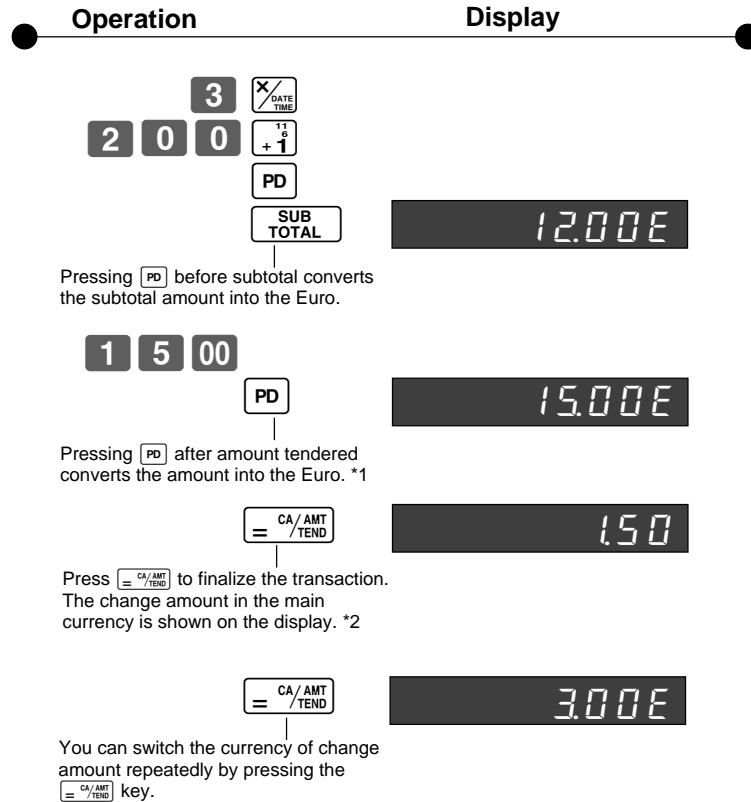

*1 If the payment is the same as the subtotal amount, you can omit this operation.

Press key directly after the subtotal.

*2 If the payment is less than the subtotal amount, the cash register specifies it as a partial payment and shows the balance in the main currency on the display.

Printout

DEPT01	3 X	@2.00	
TOTAL		.6.00	Subtotal in the main currency
		€12.00	Subtotal after conversion
EURO		€15.00	Payment in the Euro
CASH		.7.50	Payment after conversion
CHANGE		.1.50	Change in the main currency
EURO CG		€3.00	Change in the sub currency

7. Daily management report

This section tells you the procedures to use to produce reports of the transaction data stored in the cash register's memory.

Important

Remember that when you issue a reset (Z) report, the data that is reported is cleared from the applicable totalizers. To view data without clearing totalizers, issue a read (X) report.

7-1 Financial report

Operation

Printout

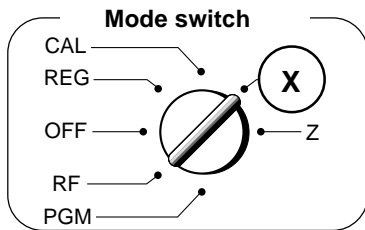

```

X 07-19-2003 14:27
                                0072
FLASH X
GROSS TOTAL QT 67
NET TOTAL No 38
CASH-INDW 270.48
CHARGE-INDW 38
CHECK-INDW 271.24
            197.57
            18.19
            45.18
    
```

Mode/Date/Time
/Consecutive No.
Report title
Gross sales No. of items
Gross sales amount
Net sales No. of customers
Net sales amount
Cash total in drawer
Charge total in drawer
Check total in drawer

7-2 Daily/Periodic read/reset report

Operation

Printout

7-2-1 Daily read/reset report

Mode switch to



(Read)



Z (Reset) report

```

Z 07-19-2003 19:35
                                0073
0000 DAILY Z 0012
DEPT01 QT 48
DEPT02 QT 50.10
DEPT03 QT 76.40
DEPT04 QT 17
DEPT05 QT 85.80
DEPT05 QT 76.00
DEPT05 QT 1
DEPT05 QT 6.80
DEPT15 QT 4
DEPT15 QT 3.00
-----
GROSS TOTAL QT 108
NET TOTAL No 316.80
CASH-INDW 46
CHARGE-INDW 325.13
CHECK-INDW 199.91
TAX-AMT1 16.22
TAX1 105.00
RF-MODE TTL No 105.10
CALCULATOR No 4.20
CASH No 2
CHARGE No 0.50
CHECK No 3
RC 44
PD 203.91
- 3
%- 16.22
ERR CORR No 2
NS No 2
GRND TTL 105.00
            6.00
            10.00
            0.50
            0.66
            21
            12
            0000832721.20
    
```

Mode/Date/Time
Consecutive No.
Report code/Title/Reset counter
Dept. name/No. of items
Amount
Gross sales No. of items
Gross sales amount
Net sales No. of customers
Net sales amount
Cash in drawer
Charge in drawer
Check in drawer
Taxable amount 1
Tax amount 1
Refund mode count
Refund mode total
CAL mode count
Cash sales count
Cash sales amount
Charge sales count
Charge sales amount
Check sales count
Check sales amount
Received on account total
Paidout total
Reduction amount
Premium/Discount amount
Error correct count
No sale count
Non resettable ground total *

Mode switch to



(Reset)



* X (Read) report has the same contents except * marked items.

7-2-2 Periodic read/reset report

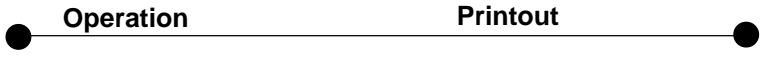

Mode switch to **Z** or **X**

1 0 = CA/AMT / TEND

Z	07-19-2003 19:50			Mode/Date/Time
	0074			Consecutive No.
0010 PERIODIC		ZZ 0001		Report code/Title/Reset counter
GROSS TOTAL	QT	67		Gross sales No. of items
		-270.73		Gross sales amount
NET TOTAL	No	38		Net sales No. of customers
		-271.24		Net sales amount



CONVENIENT OPERATION

1. Various programming

1-1 Unit price for departments

Example

Unit Price	\$1.00	\$2.20	\$11.00
Dept.	1	2	13

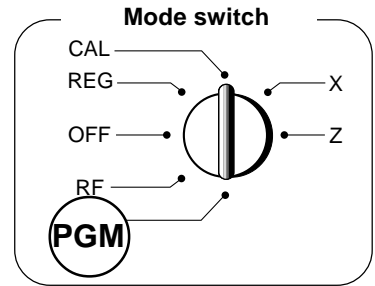
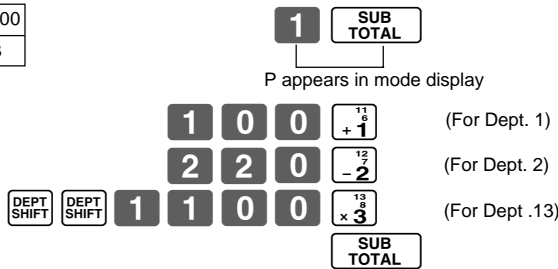

- Unit prices within the range of 0.01~9999.99.

1-2 Rate for percent key

Example

Discount Rate	2.5%
---------------	------

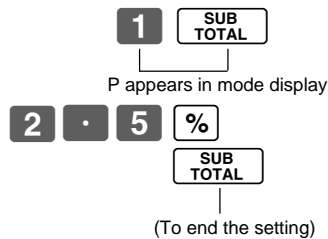

- The rate within the range of 00.01 to 99.99%.

1-3 To change tax status for departments

Tax status for the departments 1~4 are initialized as nontaxable.

Example

Status	Taxable 1	Taxable 2
Depts.	1	2

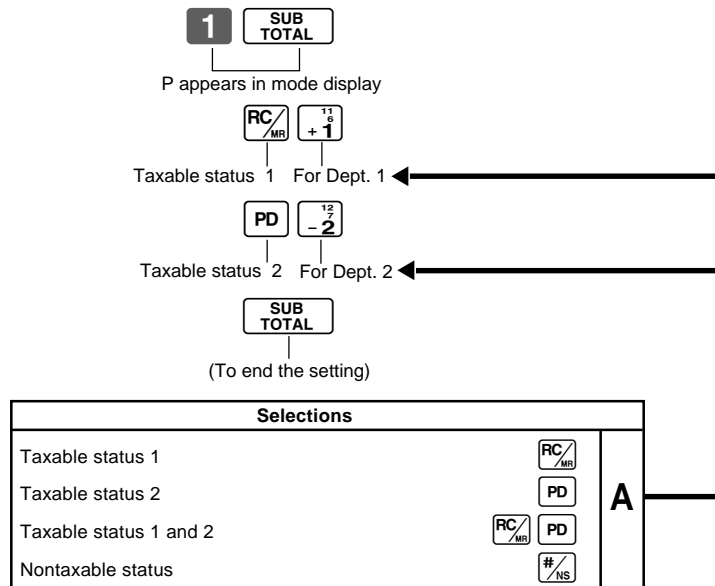

Part-2

1-4 Status for department

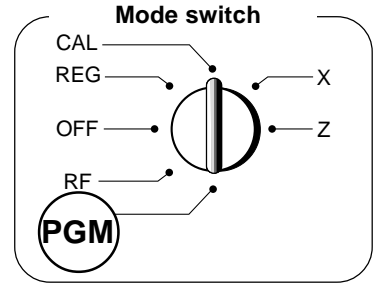

Example

Depts.	Selections		
	A	B	C
1	0	4	1
7	0	5	1

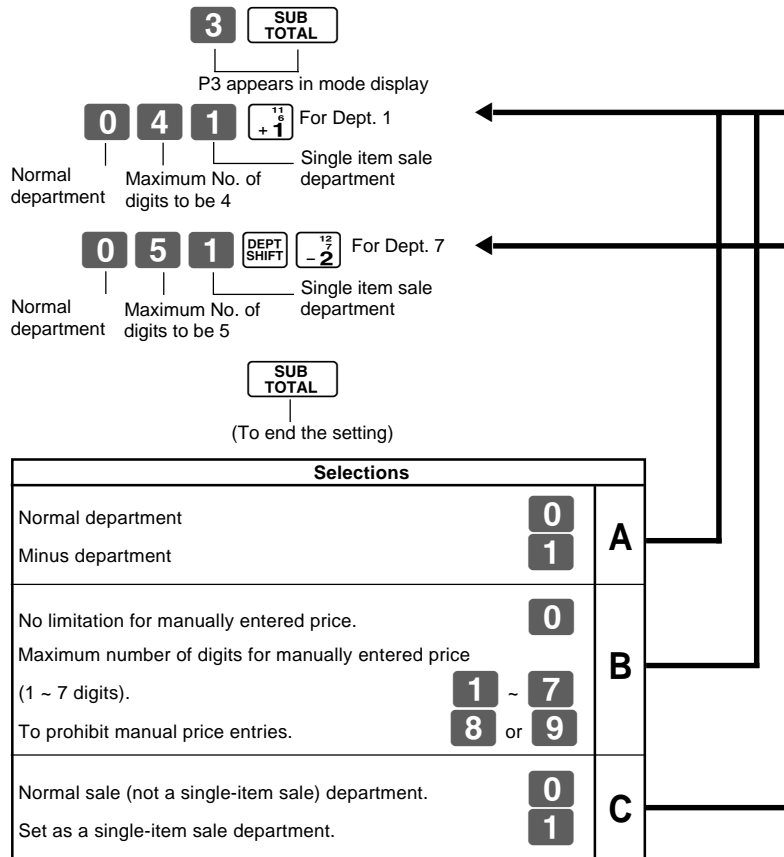

1-5 Status for percent key

1-5-1 To change taxable status for the percent key

The percent key is initialized as nontaxable.

Example

Change percent key registration as a taxable status 1.

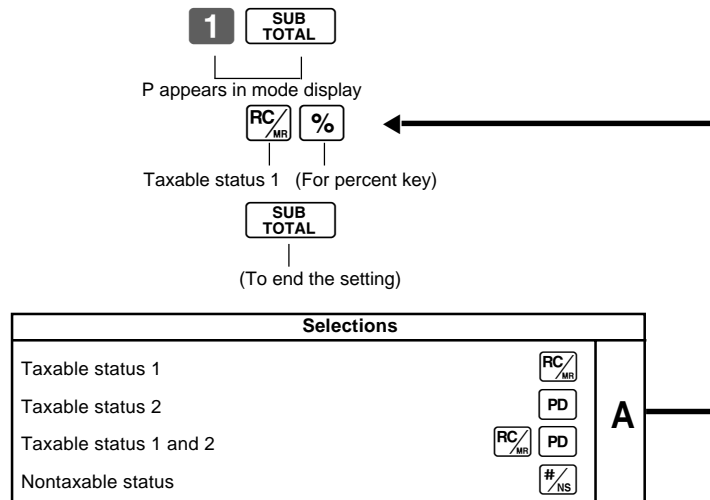

1-5-2 Status for percent key

Example

Round	Up
Percent	%+

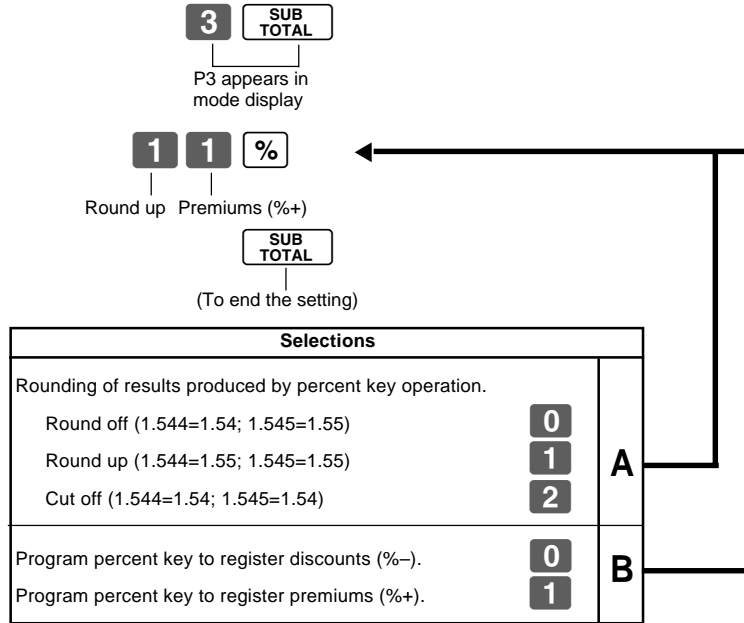

Part-2

1-6 Taxable status for minus key

Example :

Change minus key registrations taxable status 1.

The minus key is initialized as nontaxable.

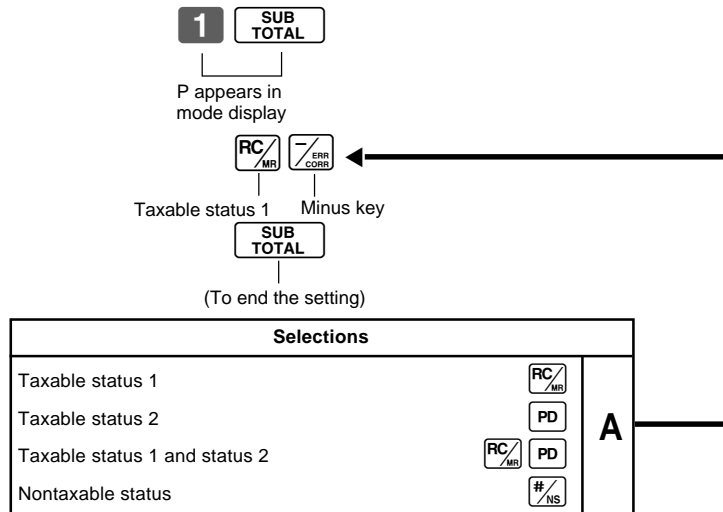

1-7 General features

1-7-1 To set general controls

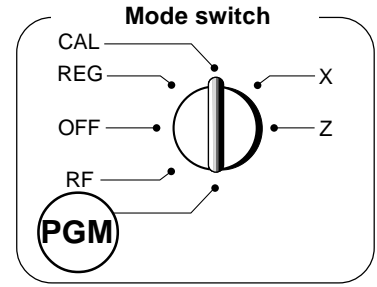
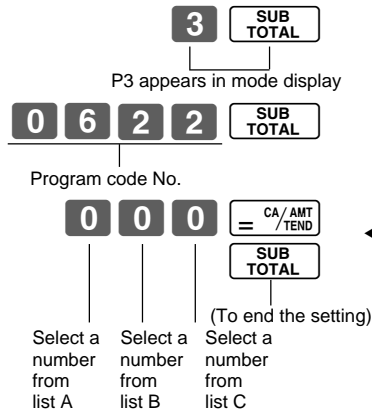

				Selections	
Maintain key buffer during receipt issue in REG mode.					
Reset the transaction number to zero whenever a daily reset report is issued.					
Allow credit balance registration.					
No	Yes	Yes	0	A	
		No	1		
	No	Yes	2		
		No	3		
Yes	Yes	Yes	4		
		No	5		
	No	Yes	6		
	No	No	7		

				Selections	
Limit the last 2 digits of cash amount tendered to 00, 25, 50 and 75 when Danish rounding is specified for subtotal and total amount.					
Allow partial cash amount tendered.					
Allow partial check amount tendered.					
Yes	Yes	No	0	B	
		Yes	1		
	No	No	2		
		Yes	3		
No	Yes	No	4		
		Yes	5		
	No	No	6		
	No	Yes	7		

Selections	
Use the 00 key on a numeric keyboard.	0
Use the 00 key as a 000 key.	1

C

1-7-2 To set printing controls

3 SUB TOTAL

P3 appears in mode display

0 5 2 2 SUB TOTAL

Program code No.

0 0 0 0 CA/AMT / TEND

Select a number from list A

Select a number from list B

Select a number from list C

Select a number from list D

SUB TOTAL (To end the setting)

Selections				
Use the printer to print a journal.	0		A	
Use the printer to print receipts.	1			
Selections				
Print zero-total item on the daily/periodic read/reset reports				
Print receipt by single/double height characters.				
Print total line at finalization.				
No	BY SINGLE HEIGHT	Yes	0	B
		No	1	
	BY DOUBLE HEIGHT	Yes	2	
		No	3	
Yes	BY SINGLE HEIGHT	Yes	4	
		No	5	
	BY DOUBLE HEIGHT	Yes	6	
		No	7	
Selections				
Print RF mode count/amount on the daily read/reset report.				
Print the grand sales total on the daily reset report.				
Print the time on the receipt and journal.				
Yes	No	Yes	0	C
		No	1	
	Yes	Yes	2	
		No	3	
No	No	Yes	4	
		No	5	
	Yes	Yes	6	
		No	7	
Selections				
Print the consecutive number on the receipt/journal.				
Print the subtotal on the receipt/journal when the subtotal key is pressed.				
Skip item print on journal.				
No	No	Yes	0	D
		No	1	
	Yes	Yes	2	
		No	3	
Yes	No	Yes	4	
		No	5	
	Yes	Yes	6	
		No	7	

1-7-3 Printer switch for receipt or journal

The printer is initialized as journal.

Example

To print a receipt

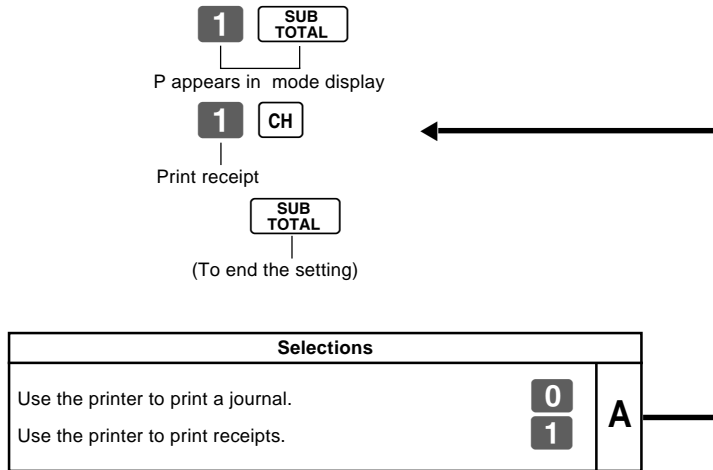
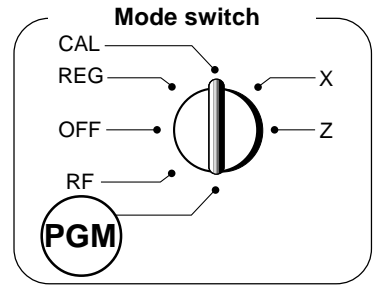

- Printer selection to print a journal or receipts can also be set on procedures 1-7-2 "To set printing controls".

1-8 Setting the tax rate and rounding

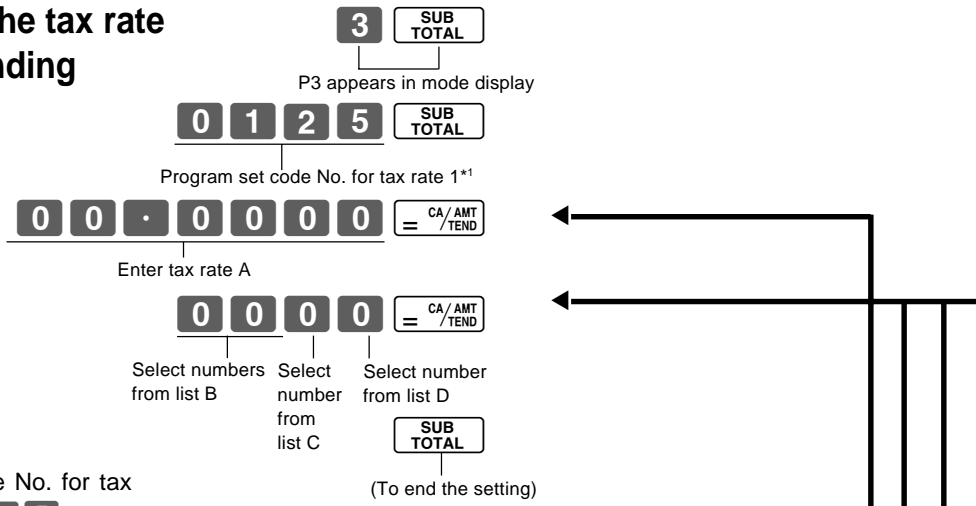

*1 Program set code No. for tax rate 2 is **0 2 2 5**.

- You can use either an add-on rate tax or an add-in rate tax (VAT), depending on the requirements in your area. You can specify only one tax rate.
- The normal rounding specification tells the cash register how to round tax amounts to the proper number of decimal places.
- The special rounding specification and Danish rounding tell the cash register how to round off subtotals and totals so that their least 2 digits are 00, 25, 50 and 75.
- Note that the rounding specification you program for your cash register depends on the tax laws of your country.

Tax rate specifications	
The tax rate within the range of 0.0001 ~ 99.9999%. Use . key for decimal point.	A
Normal rounding specifications	
Cut off to 2 decimal places. (1.544=1.54, 1.545=1.54)	0 0
Round off to 2 decimal places. (1.544=1.54, 1.545=1.55)	5 0
Round up to 2 decimal places. (1.544=1.55, 1.545=1.55)	9 0
Special rounding specifications for subtotal and total amounts	
No specifications	0
Special rounding 1 0 ~ 2 → 0, 3 ~ 7 → 5, 8 ~ 9 → 10 Examples: 1.21=1.20, 1.26=1.25, 1.28=1.30	1
Special rounding 2 0 ~ 4 → 0, 5 ~ 9 → 10 Examples: 1.123=1.120, 1.525=1.530	2
Danish rounding (set the amount tender restriction on page 22 also) 00~ 12 → 0, 13 ~ 37 → 25, 38 ~ 62 → 50, 63 ~ 87 → 75, 88 ~ 100 → 100 Examples: 1.11=1.00, 1.28=1.25, 1.39=1.50, 1.80=1.75, 1.99=2.00	3
Scandinavian rounding 00~ 24 → 0, 25 ~ 74 → 50, 75 ~ 99 → 100 Examples: 1.21=1.0, 1.30=1.50, 1.87=2.00	6
Australian rounding (only for tax rate 1) 0 ~ 2 → 0, 3 ~ 7 → 5, 8 ~ 9 → 10 Examples: 1.21=1.20, 1.26=1.25, 1.28=1.30	7
Tax system specifications for subtotal and total amounts	
No specifications.	0
Specifies add-on rate tax.	2
Specifies add-in rate tax (VAT).	3

Part-2

1-9 To control tax status printing

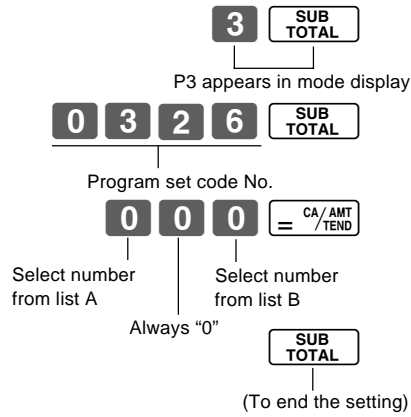
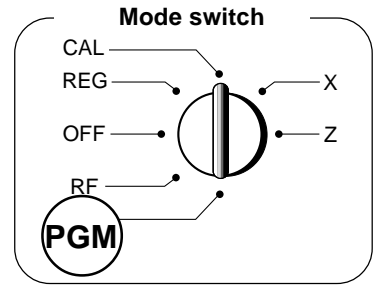

		Selections	
Print tax total line (only for Australia).			
Print tax symbol (only for Australia).			
Yes	No	0	A
	Yes	1	
No	No	2	
	Yes	3	

		Selections	
Print taxable amount.			
Print taxable amount and tax amount for Add-in.			
Yes	Yes	0	B
	No	1	
No	Yes	2	
	No	3	

1-10 To program department, PLU, clerk name

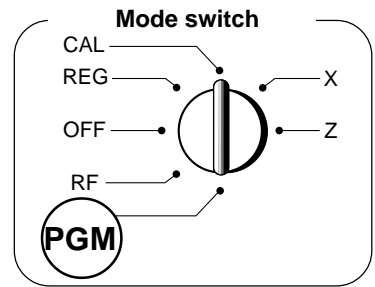

1-10-1 Character keyboard

In the PGM 2 mode, the keyboard becomes character setting keyboard illustrated below after specifying a department, or a message.

- ① Double size key
Use this key to specify the next character to a double sized character. You must press this key before each double sized character.
- ② Alphabet keys
Use these keys to input characters. Refer to the next page to enter characters.
- ③ Right arrow key
Use this key to input the character located on the same alphabet key. This key is also used for inputting a space.
- ④ Delete key
Use this key to delete character just entered.
- ⑤ Department keys
Use this key to specify department.
- ⑥ Department shift key
Use this key to shift department.

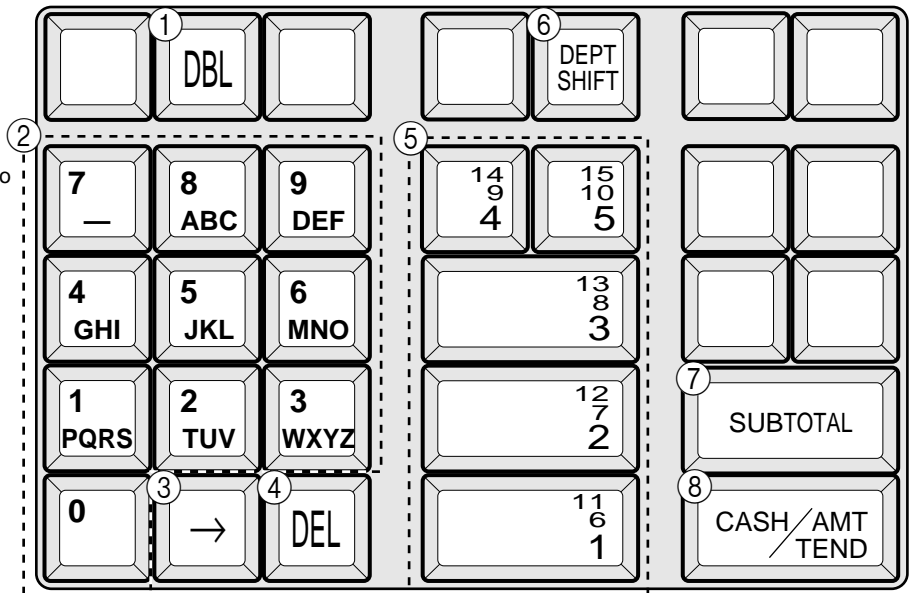

- ⑦ Program end key (SUB TOTAL key)
Use this key to terminate character programming.
- ⑧ Character program key (CA/AMT/TEND key)
Use this key to program the department / message characters just entered before.

1-10-2 Programming department name

Example

Department	1	7
Name	DAIRY	HBA

up to 8 (4 double sized) characters

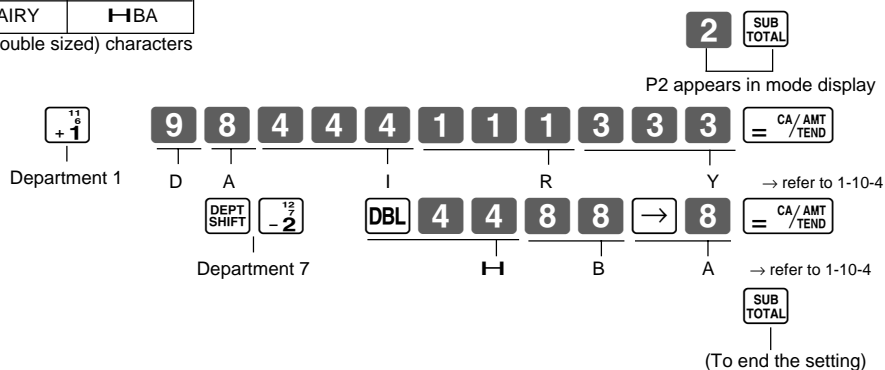

Part-2

1-10-3 Programming receipt message

Example

Line (1 ~ 5)	2
Message	THANK YOU

up to 24 (12 double sized) characters

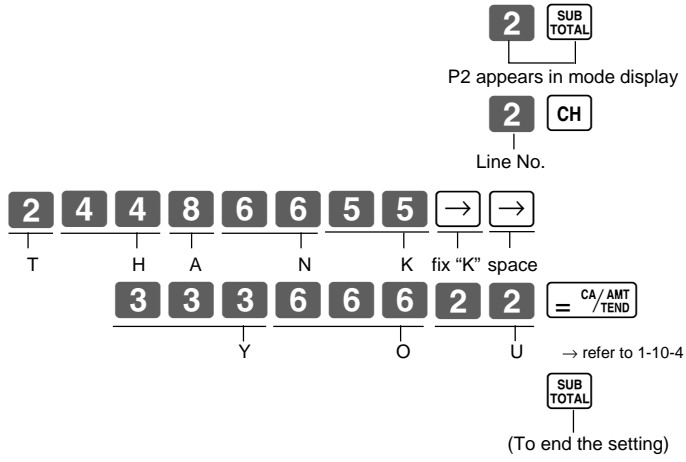

1-10-4 Alphabetical order

Characters are assigned to each numeric key. You can enter "A" by pressing **8** once, "B" twice, "C" three times ...

The following tables indicate character assignment and the depression numbers of the key to enter the appropriate character.

A, B, C, a, b, c, 8, ... 8 key	: A .01 → B .02 → C .03 → a .04 → b .05 → c .06 → 8 .07 →
	→ Ä .08 → Å .09 → Æ .10 → Ǻ .11 → ǻ .12 → Ǽ .13 → Ǿ .14 →
	→ Ç .15 → â .16 → ã .17 → ä .18 → å .19 → æ .20 → ǿ .21 →
	→ ã .22 → ç .23 → returns to the beginning
D, E, F, d, e, f, 9, ... 9 key	: D .01 → E .02 → F .03 → d .04 → e .05 → f .06 → 9 .07 →
	→ Ð .08 → É .09 → Ê .10 → Ë .11 → Ï .12 → ð .13 → é .14 →
	→ ê .15 → ë .16 → è .17 → f .18 → returns to the beginning
G, H, I, g, h, i, 4, ... 4 key	: G .01 → H .02 → I .03 → g .04 → h .05 → i .06 → 4 .07 →
	→ Ĝ .08 → Ĥ .09 → Ĭ .10 → Ĵ .11 → İ .12 → ı .13 → İ .14 →
	→ ı .15 → ı .16 → returns to the beginning
J, K, L, j, k, l, 5, 5 key	: J .01 → K .02 → L .03 → j .04 → k .05 → l .06 → 5 .07 →
	→ returns to the beginning
M, N, O, m, n, o, 6, ... 6 key	: M .01 → N .02 → O .03 → m .04 → n .05 → o .06 → 6 .07 →
	→ Ñ .08 → Ö .09 → Ø .10 → Ó .11 → Ô .12 → Õ .13 → Ö .14 →
	→ ñ .15 → ô .16 → ö .17 → õ .18 → ø .19 → ó .20 → ö .21 →
	→ returns to the beginning

P, Q, R, S, p, q, r, s, 1, ... 1 key	P .01 → Q .02 → R .03 → S .04 → p .05 → q .06 → r .07 →
	s .08 → 1 .09 → P .10 → p .11 → β .12 → returns to the beginning
T, U, V, t, u, v, 2, ... 2 key	T .01 → U .02 → V .03 → t .04 → u .05 → v .06 → 2 .07 →
	Ü .08 → ú .09 → Û .10 → ü .11 → ü .12 → û .13 → û .14 →
	û .15 → μ .16 → returns to the beginning
W, X, Y, Z, w, x, y, z, 3, ... 3 key	W .01 → X .02 → Y .03 → Z .04 → w .05 → x .06 → y .07 →
	z .08 → 3 .09 → ÿ .10 → ÿ .11 → ÿ .12 → returns to the beginning
0 0 key	0 .01 → returns to the beginning
7, Symbols, ... 7 key	? .01 → @ .02 → - .03 → / .04 → : .05 → ! .06 → ? .07 →
	~ .08 → (.09 →) .10 → * .11 → # .12 → + .13 → , .14 →
	^ .15 → ; .16 → < .17 → = .18 → > .19 → \$.20 → ¥ .21 →
	% .22 → & .23 → [.24 →] .25 → ^ .26 → { .27 → .28 →
	} .29 → · .30 → " .31 → ' .32 → \ .33 → _ .34 → ~ .35 →
	£ .36 → × .37 → ¿ .38 → ¡ .39 → € .40 → § .41 → space .42 →
	→ returns to the beginning

Cf.

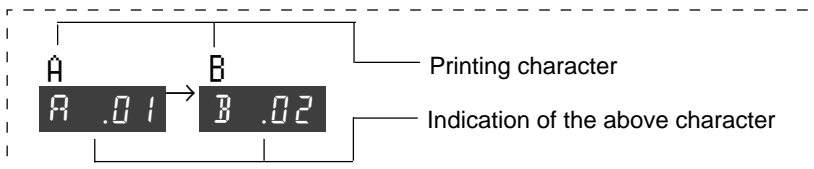

1-11 Printing to read all preset data

Operation

Printout

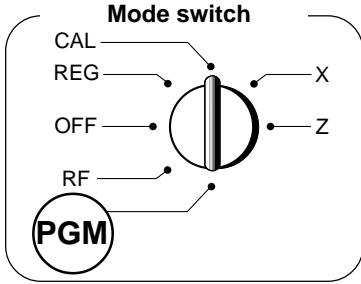

CA / AMT / TEND

PGM1			Read Symbol
DEPT01	T1	@1.00	Dept. name/Tax status/Unit price
000			Normal dept./Digit limit/Single item
DEPT02		@10.00	
000			
DEPT15		@5.00	
000			
-	T1		Minus/Tax status
%-	T1	12.34%	Percent/Tax status/Rate
00			Fraction/Key attribution
EURO		€1.29739	Euro conversion rate
0122		22	Date, Add mode control (fixed)
0522		1020	Print control
0622		0000	General control
1022		0	Calculation control
0326		202	Tax control
2422		22	Euro program
0125			Tax table 1
		0.0000 %	
		5003	
		0000	
0225			Tax table 2
		5.2500 %	
		5003	
		0000	
		01	Receipt message
		02	
YOUR RECEIPT			
		03	
TAXABLE SUPPLY			

Part-2

2. Various operations

2-1 Registration using preset price for departments.

(Programming: See page 19)

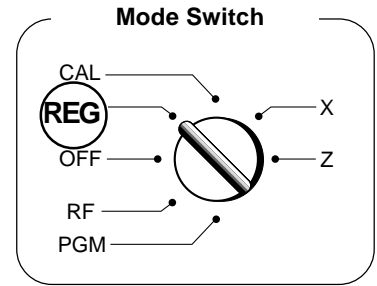

Example

Unit Price	\$1.00	\$2.20	\$11.00
Quantity	1	2	4
Depts.	1	2	3
Amount tendered	\$50.00		

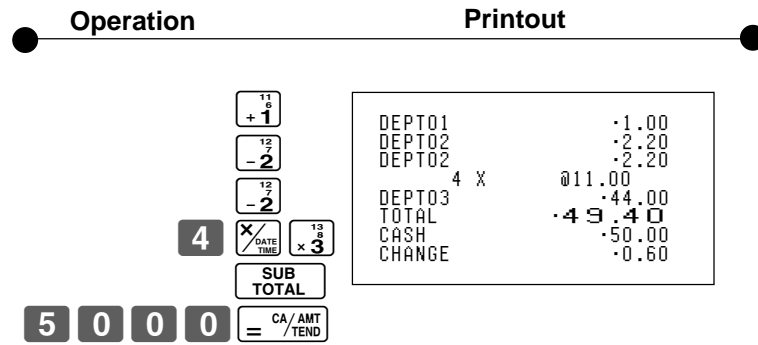

2-2 Single-Item Sales

(Programming: See page 20)

Example 1:

Status	Single item sale	
Unit Price	\$0.50	
Quantity	1	
Dept.	1	

5 0 + 1

DEPT01	.0.50	Cash sales
CASH	.0.50	

Example 2:

Status	Normal	Single item sale
Unit Price	\$1.00	\$0.50
Quantity	1	1
Dept.	2	1

1 0 0 - 2
5 0 + 1
SUB TOTAL
CA/AMT/TEND

DEPT02	.1.00	Cash sales
DEPT01	.0.50	
CASH	.1.50	

Single-item sale cannot be finalized if an item is registered previously.

2-3 Check sales

Example:

Unit Price	\$35.00
Quantity	2
Dept.	4

3 5 0 0 ÷ 4
÷ 4
SUB TOTAL
CHK

DEPT04	.35.00	Check sales
DEPT04	.35.00	
CHECK	.70.00	

2-4 Split cash/ check sales

Example:

Unit Price	\$30.00	\$25.00
Quantity	1	1
Depts.	2	3
Cash amount tendered	\$20.00	
Check	\$35.00	

Operation **Printout**

3 0 0 0 ¹²/₇ - 2

2 5 0 0 ¹³/₈ x 3

SUB TOTAL

2 0 0 0 = CA/AMT/TEND

CHK

DEPT02 .30.00
 DEPT03 .25.00
 TOTAL .55.00
 CASH .20.00
 CHARGE .35.00

2-5 Post receipt issuance

Example

Unit price	\$1.00	\$2.00
Quantity	1	1
Depts.	1	2
Cash amount tendered	\$5.00	

You can issue a post receipt after finalizing a transaction by pressing ●.

Note that all of the following condition must be satisfied:

- Print "receipt" option is selected.
- The receipt issuance status must be "OFF".
- The transaction must be finalized in the REG/RF mode using = CA/AMT/TEND, CH or CHK.

1 0 0 0 ¹¹/₀ + 1

2 0 0 0 ¹²/₇ - 2

SUB TOTAL

5 0 0 0 = CA/AMT/TEND

(Receipt is not issued.)

●

(Receipt is issued.)

Note:

You can issue only one post receipt per transaction.

(Post receipt)

DEPT01	.1.00
DEPT02	.2.00
TOTAL	.3.00
CASH	.5.00
CHANGE	.2.00

If the transaction contains more than 20 lines (including receipt header), then the total formatted post receipt is issued.

(Total formatted post receipt)

CASH	.3.00
------	-------

2-6 Refund

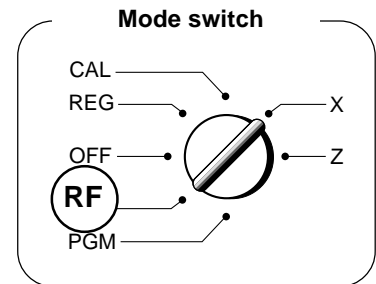

Operation **Printout**

1 0 0 0 ¹²/₇ - 2

2 0 0 0 ¹³/₈ x 3

SUB TOTAL

= CA/AMT/TEND

RF 07-19-2003 13:55
0040

DEPT02 .1.00
 DEPT03 .2.00
 CASH .3.00

Example

Unit Price	\$1.00	\$2.00
Quantity	1	1
Dept.	2	3

After you finish RF mode operation, be sure to return the mode switch to the REG (register) setting.

Mode switch

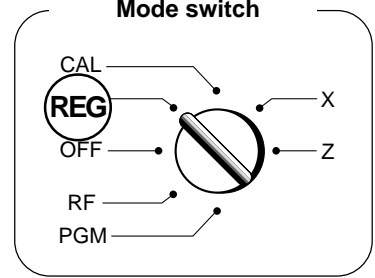

2-7 Other registrations

2-7-1 Reading the time and date

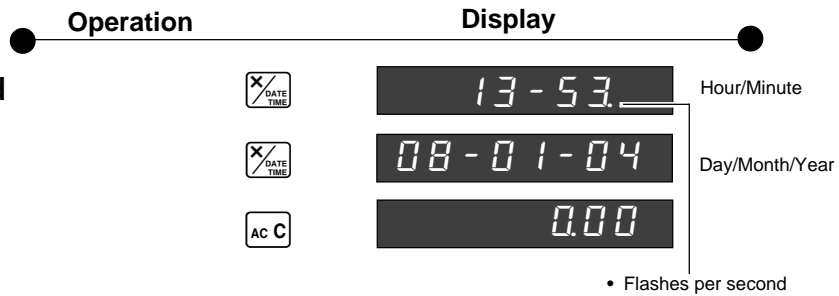

2-7-2 Payout from cash in drawer

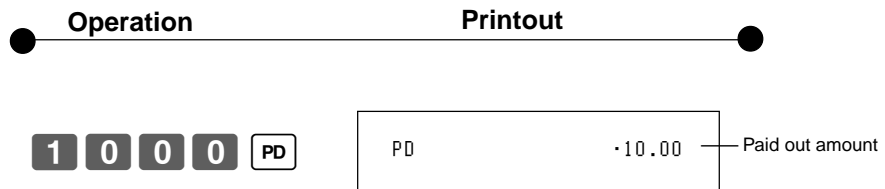

2-7-3 Cash received on account

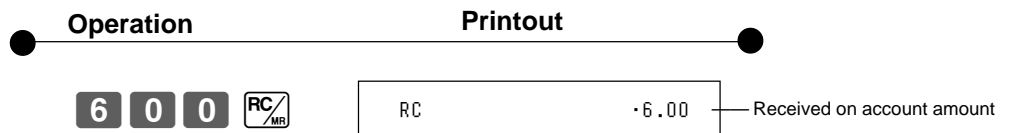

2-7-4 Registering identification numbers

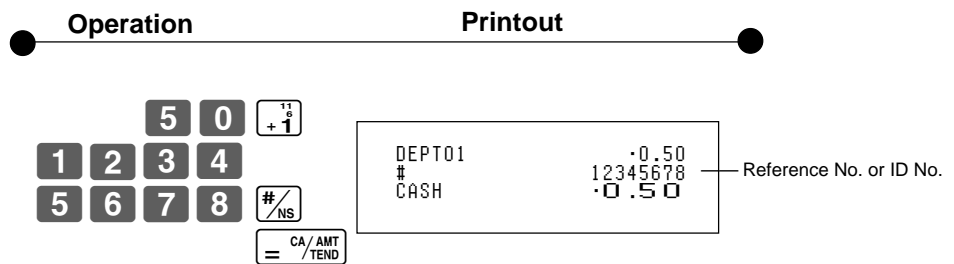

A reference number or ID number of up to 8 digits can be registered prior to any transaction.

2-7-5 Reduction on subtotal

Example:
Amount due reduced by \$0.50.

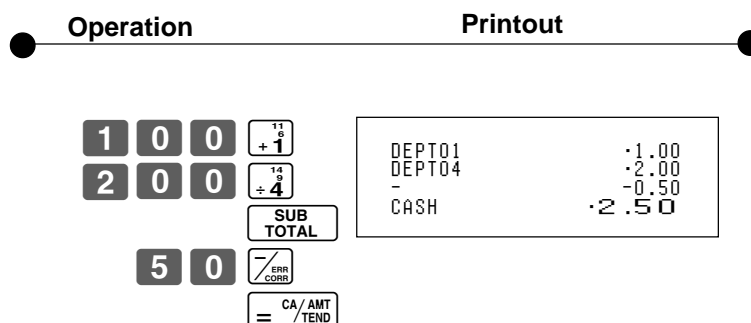

2-7-6 Premium/Discount

- 2.5% premium/discount (programmed to [%] key) applied to first item.

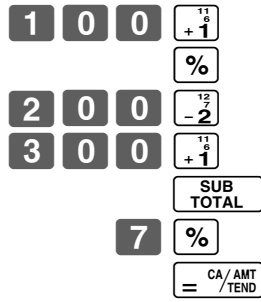

- 7% premium/discount applied to transaction total.
- For programming the [%] key as percent minus or percent plus, see page 21.
- For programming percent rate, see page 19.

Premium

DEPT01	·1.00	Premium rate
2.5%		Premium amount
%+	·0.03	
DEPT02	·2.00	
DEPT01	·3.00	Subtotal
ST	·6.03	Premium rate
7%		Premium amount
%+	·0.42	
CASH	·6.45	

Discount

DEPT01	·1.00	Discount rate
2.5%		Discount amount
%-	·0.03	
DEPT02	·2.00	
DEPT01	·3.00	Subtotal
ST	·5.97	Discount rate
7%		Discount amount
%-	·0.42	
CASH	·5.55	

Part-2

2-8 About the daylight saving time

It is possible to set the internal clock forward/backward by 1~9 hour(s) for the daylight saving time.

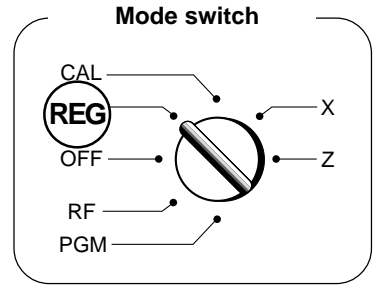

- Forward by 1 hour

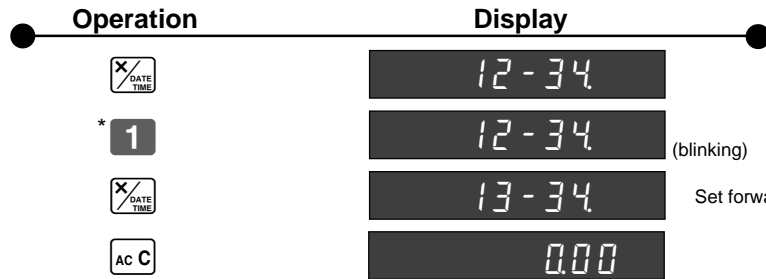

- Backward by 1 hour



*Put [2]~[9], in case of set the clock by 2~9 hours.

Part 3

CALCULATOR FUNCTION

1. Calculator Mode

While registering at REG mode, you can switch to CAL mode and then return to REG mode to resume the registration.

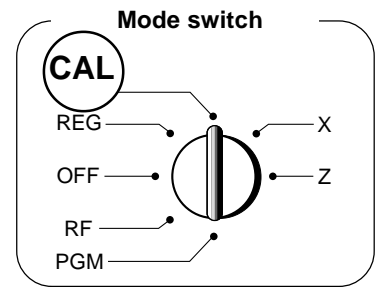

1-1 Calculation examples

Operation	Display
$5 + 3 - 2 =$ $(23 - 56) \times 78 =$ 12% on 1500	<div style="border: 1px solid black; padding: 5px; width: 100px; margin-bottom: 5px;">0</div> <div style="border: 1px solid black; padding: 5px; width: 100px; margin-bottom: 5px;">6</div> <div style="border: 1px solid black; padding: 5px; width: 100px; margin-bottom: 5px;">-2574</div> <div style="border: 1px solid black; padding: 5px; width: 100px;">180</div>
<div style="display: flex; justify-content: center; gap: 5px; margin-bottom: 5px;"> 5 + 1 AC c </div> <div style="display: flex; justify-content: center; gap: 5px; margin-bottom: 5px;"> 5 + 1 AC c </div> <p style="text-align: center; margin: 0;">(Miss operation) (Cancels item entered.)</p> <div style="display: flex; justify-content: center; gap: 5px; margin-bottom: 5px;"> 5 + 3 - 2 = CA/AMT/TEND </div> <div style="display: flex; justify-content: center; gap: 5px; margin-bottom: 5px;"> 2 3 - 5 6 × 7 8 = CA/AMT/TEND </div> <div style="display: flex; justify-content: center; gap: 5px;"> 1 5 0 0 × 1 2 % </div>	

1-2 Memory recall

Recalls the current amount onto the display.

- during registration: current subtotal
- registration has been completed: the last amount

On CAL mode

Example:
Divide the current subtotal \$30.00 at REG mode by 3 (to divide the bill between 3 people).

Operation	Display
<div style="display: flex; justify-content: center; gap: 5px; margin-bottom: 5px;"> RC/MR ÷ 3 = CA/AMT/TEND </div> <p style="text-align: center; margin: 0;">Memory recall</p>	<div style="border: 1px solid black; padding: 5px; width: 100px;">10</div>

On REG mode

Recalls the current result by pressing = CA/AMT/TEND key at CAL mode on the display.

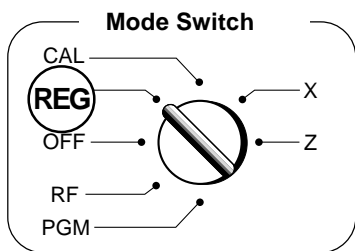

Example:
Recall the current result at CAL mode during registration, and register the cash amount due for each person.

Operation	Printout														
<div style="display: flex; justify-content: center; gap: 5px; margin-bottom: 5px;"> RC/MR = CA/AMT/TEND </div> <div style="display: flex; justify-content: center; gap: 5px; margin-bottom: 5px;"> RC/MR = CA/AMT/TEND </div> <div style="display: flex; justify-content: center; gap: 5px;"> RC/MR = CA/AMT/TEND </div> <p style="text-align: center; margin: 0;">Memory recall</p>	<div style="border: 1px solid black; padding: 5px; width: 150px;"> <table style="width: 100%; border-collapse: collapse;"> <tr><td>DEPT01</td><td style="text-align: right;">-10.00</td></tr> <tr><td>DEPT02</td><td style="text-align: right;">-20.00</td></tr> <tr><td>TOTAL</td><td style="text-align: right;">-30.00</td></tr> <tr><td>CASH</td><td style="text-align: right;">-10.00</td></tr> <tr><td>CASH</td><td style="text-align: right;">-10.00</td></tr> <tr><td>CASH</td><td style="text-align: right;">-10.00</td></tr> <tr><td>CHANGE</td><td style="text-align: right;">-0.00</td></tr> </table> </div>	DEPT01	-10.00	DEPT02	-20.00	TOTAL	-30.00	CASH	-10.00	CASH	-10.00	CASH	-10.00	CHANGE	-0.00
DEPT01	-10.00														
DEPT02	-20.00														
TOTAL	-30.00														
CASH	-10.00														
CASH	-10.00														
CASH	-10.00														
CHANGE	-0.00														

1-3 Setting for calculator operation

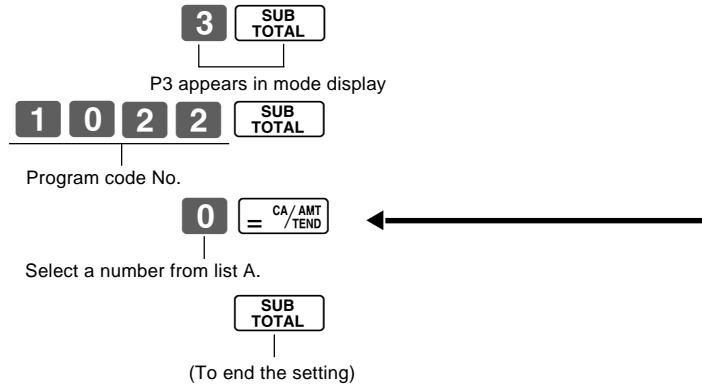
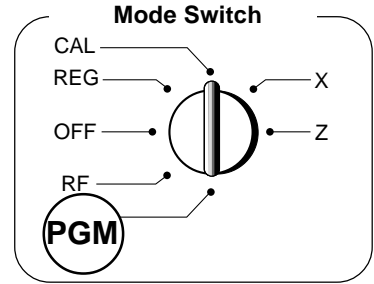

			Selections	
Open drawer whenever <input type="checkbox"/> $\frac{CA}{AMT}$ / $\frac{TEND}{TEND}$ is pressed.*				
Open drawer whenever <input type="checkbox"/> #/ is pressed.				
Print No. of Equal key operations on General Control X and Z reports.				
Yes	No	No	0	A
		Yes	1	
	Yes	No	2	
		Yes	3	
No	No	No	4	
		Yes	5	
	Yes	No	6	
		Yes	7	

* Drawer does not open during registration procedures even if you press $\frac{CA}{AMT}$ / $\frac{TEND}{TEND}$ by turning the mode switch to CAL position.

Part-3

1. Troubleshooting

	Symptom/Problem	Most common causes	Solutions
1	E01 appears on the display.	Changing modes without completing transaction.	Return key to where it stops buzzing and press  .
2	E10 appears on the display.	Printer is not closed steadily. No paper	Close the printer steadily. Replace new paper roll.
If there is enough paper installed, open the printer and set the platen arm again.			
3	No date or time on receipt. Paper is not advancing enough.	Printer is programmed as a journal.	Program printer to print receipts.
4	Key won't turn to Z, X, PGM and RF modes.	Using OP key.	Use the PGM key.
5	Drawer opens up after ringing up only one time.	Department is programmed as a single item dept.	Program the dept. as a normal dept.
6	Not clearing totals at end of day after taking report.	Using X mode to take out reports.	Use Z mode to take out reports.
7	Programming is lost whenever register is unplugged or there is a power outage.	Bad or no batteries.	Put in new batteries.
8	Register is inoperative. Can't get money out of drawer.	No power.	Pull lever underneath register at rear.

When the cash drawer does not open!

In case of power failure or the machine is in malfunction, the cash drawer does not open automatically. Even in these cases, you can open the cash drawer by pulling drawer release lever (see below).

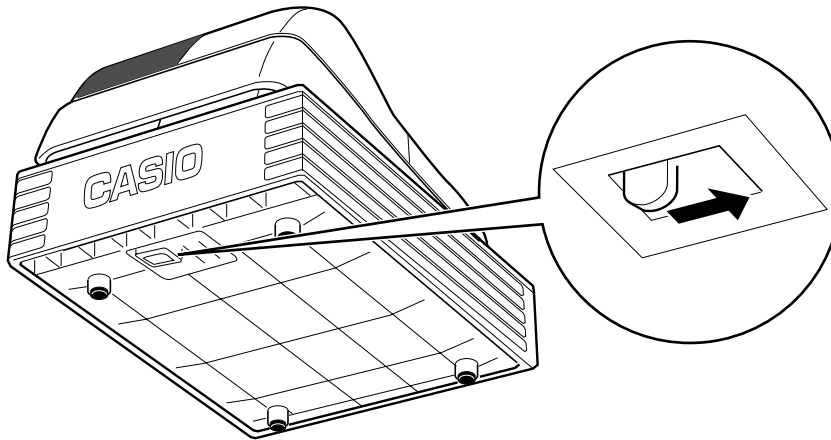

Important!

The drawer will not open, if it is locked with a drawer lock key.

2. Specifications

Input method:

Entry: 10-key system; Buffer memory 16 keys (2-key roll over)
 Display (Digitron): Amount 8 digits (zero suppression); Department No.; No. of repeats; TOTAL; CHANGE

Printer:

Receipt: 24 digits
 (or journal) Automatic paper roll winding (journal)
 Paper roll: 58 mm × 80 mm Ø (Max.)

Calculations:

Entry 8 digits; Registration 7 digits; Total 8 digits

Calculator function:

8 digits; Arithmetic calculations; Percent calculations

Memory protection batteries:

The effective service life of the memory protection batteries (3 UM-3, R6P (SUM-3) or LR6 (AM-3) type batteries) is approximately one year from installation into the machine.

Power source/Power consumption:

See the rating plate.

Operating temperature: 0°C to 40°C (32°F to 104°F)

Humidity: 10 to 90%

Dimensions/Weight: 330 mm (W) × 360 mm (D) × 197 mm (H) with S drawer
 4 kg with S drawer
 410 mm (W) × 450 mm (D) × 240 mm (H) with M drawer
 9 kg with M drawer

Specifications and design are subject to change without notice.

The main plug on this equipment must be used to disconnect mains power. Please ensure that the socket outlet is installed near the equipment and shall be easily accessible.



Casio Electronics Co., Ltd.
 Unit 6, 1000 North Circular Road
 London NW2 7JD, U.K.

Please keep all information for future reference.

CASIO®

CASIO COMPUTER CO., LTD.
6-2, Hon-machi 1-chome
Shibuya-ku, Tokyo 151-8543, Japan

MO0306-A

TE-M80*E
Printed in Indonesia
Printed on recycled paper.